



National Aeronautics and
Space Administration

Educational Product	
Educators	Grades 2-4
EG-2002-06-105-HQ	

AERONAUTICS

**An Educator's Guide with Activities in Science,
Mathematics, and Technology Education**





Aeronautics—An Educator’s Guide with Activities in Science, Mathematics, and Technology Education is available in electronic format through NASA Spacelink—one of the Agency’s electronic resources specifically developed for use by the educational community.

This guide and other NASA education products may be accessed at the following Address:
<http://spacelink.nasa.gov/products>

Aeronautics

An Educator's Guide with Activities in Science, Mathematics, and Technology Education

What pilot, astronaut, or aeronautical engineer
didn't start out with a toy glider?

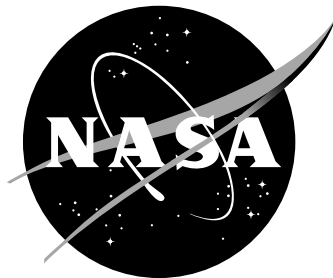

National Aeronautics and Space Administration

This publication is in the Public Domain and is not protected by copyright.
Permission is not required for duplication.

EG-2002-06-105-HQ

Table of Contents

Acknowledgments	1
Preface/How to Use This Guide	2
Matrices	
Science Standards	3
Mathematics Standards	4
Science Process Skills	5
Aerospace Technology Enterprise	6
Aeronautics Background for Educators	7

Activities

Air

Air Engines	12
Dunked Napkin	17
Paper Bag Mask	23
Wind in Your Socks	29
Air: Interdisciplinary Learning Activities	36

Flight

Bag Balloons	40
Sled Kite	44
Right Flight	52
Delta Wing Glider	60
Rotor Motor	69
Flight: Interdisciplinary Learning Activities	76

We Can Fly, You and I

Making Time Fly	80
Where is North? The Compass Can Tell Us	87
Let's Build a Table Top Airport	91
Plan to Fly There	97
We Can Fly, You and I: Interdisciplinary Learning Activities	107



Appendix

The Parts of an Airplane	110
Aeronautical Glossary	111
Suggested Reading	115
NASA Resources for Educators	118
Evaluation Reply Card	Back Cover





Acknowledgements

Editors

Pat Biggs
Ted Huetter

Contributors/Writers

Charles Anderson
Pat Biggs
Deborah Brown
Steve Culivan
Sue Ellis
James Gerard
Ellen Hardwick
Norm Poff
Carla Rosenberg
Deborah Shearer
Octavia Tripp
Ron Ernst

Art Direction and Layout

Ted Huetter

Graphic Illustration

Rod Waid

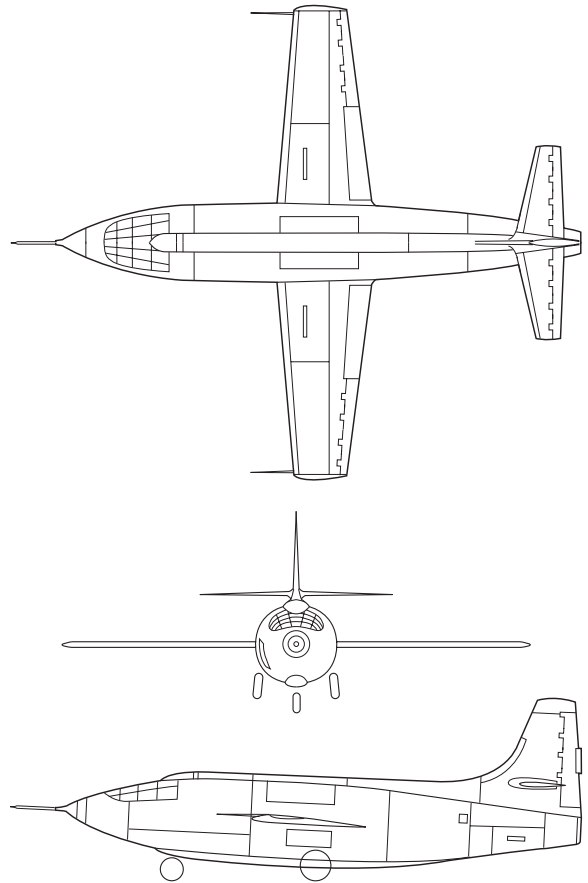

**NACA X-1 Research Aircraft
1946**

Photography

(Numbered clockwise from upper left) NACA file photos 2, 7,13,14,NASA file photo 5,
Nick Galante 3, Mike Smith 4, Jim Ross 11, 12, Ted Huetter 1, 6, 8, 9, 10 Cover
Ted Huetter Page 11
NASA file photo Page 39
Carla Thomas Page 79
Carla Thomas Page 109

Special thanks to:

Michelle Davis, Lee Duke, Jim Fitzgerald, Deborah Gallaway, Jane George, Doris Grigsby, Yvonne Kellogg, Marianne McCarthy, Joan Sanders, Greg Vogt, Deborah Dyer Wahlstrom, and Ralph Winrich. NACA/NASA aircraft technical drawings by Dennis Calaba and Marco Corona.

This guide was produced at NASA Dryden Flight Research Center, Edwards, CA, with graphics support from NASA Langley Research Center, Hampton, VA.



Preface

Welcome to the exciting world of aeronautics. The term aeronautics originated in France, and was derived from the Greek words for “air” and “to sail.” It is the study of flight and the operation of aircraft. This educator guide explains basic aeronautical concepts, provides a background in the history of aviation, and sets them within the context of the flight environment (atmosphere, airports, and navigation).

The activities in this guide are designed to be uncomplicated and fun. They have been developed by NASA Aerospace Education Services Program specialists, who have successfully used them in countless workshops and student programs around the United States. The activities encourage students to explore the nature of flight, and experience some real-life applications of mathematics, science, and technology.

The subject of flight has a wonderful power to inspire learning.

How to Use This Guide

This guide begins with education standards and skills matrices for the classroom activities, a description of the NASA aeronautics mission, and a brief history of aeronautics. The activities are divided into three chapters:

Air
Flight
We Can Fly, You and I

The activities are written for the educator. Each activity begins with (1) objectives, (2) education standards and skills, and (3) background material for the subject matter in the activity. The activity continues with by step-by-step instructions (and associated graphics) to help the educator guide students through the activity in the classroom. Each activity includes “student pages,” easily identified by this icon:



The student pages are as simple as a graphic of the activity, and as advanced as a work sheet. They are meant to supplement the educator’s presentation, serve as reminders, and inspire students to explore their own creativity. Activities requiring step-by-step assembly include student pages that present the project in a way that can be understood by pre-literate students.

Each chapter ends with a section listing suggested interdisciplinary activities.

This publication is in the public domain and is not protected by copyright. Permission is not required for duplication.



Activity Matrix

Science as Inquiry
 Position and Motion of Objects
 Physical Science
 Properties of Objects
 Unifying Concepts and Materials
 Evidence, Models, and Processes
 Science and Technology
 Science in Social and Personal Perspectives
 History and Nature of Science

- Air Engines
- Dunked Napkin
- Paper Bag Mask
- Wind in Your Socks
- Bag Balloons
- Sled Kite
- Right Flight
- Delta Wing Glider
- Rotor Motor
- Making Time Fly
- Where is North?
- Let's Build a Table Top Airport
- Plan to Fly There

●	●					●			
●		●	●		●				
●				●					
●		●					●		
●				●					
●		●		●		●			
●	●	●				●			
							●	●	
●		●				●			
	●					●	●		

Science Standards



Activity Matrix

Problem Solving
 Communication
 Reasoning
 Connections
 Measurement
 Verifying and Interpreting Results
 Estimation
 Prediction
 Graphs

Air Engines
 Dunked Napkin
 Paper Bag Mask
 Wind in Your Socks
 Bag Balloons
 Sled Kite
 Right Flight
 Delta Wing Glider
 Rotor Motor
 Making Time Fly
 Where is North?
 Let's Build a Table Top Airport
 Plan to Fly There

●				●					
					●				
●		●		●					
						●			
			●	●		●			
●		●		●			●		
●				●					
●				●		●		●	
●	●								
			●		●		●		
	●	●							
●	●		●						

Mathematics Standards



Activity Matrix

Observing
 Communication
 Measuring
 Collecting Data
 Predicting
 Making Graphics
 Investigating
 Interpreting Data
 Inferring
 Controlling Variables
 Making Models

Air Engines
 Dunked Napkin
 Paper Bag Mask
 Wind in Your Socks
 Bag Balloons
 Sled Kite
 Right Flight
 Delta Wing Glider
 Rotor Motor
 Making Time Fly
 Where is North?
 Let's Build a Table Top Airport
 Plan to Fly There

	Observing	Communication	Measuring	Collecting Data	Predicting	Making Graphics	Investigating	Interpreting Data	Inferring	Controlling Variables	Making Models
Air Engines	●				●	●	●				
Dunked Napkin	●						●				
Paper Bag Mask			●		●			●			●
Wind in Your Socks	●		●								●
Bag Balloons	●		●								●
Sled Kite	●		●		●						
Right Flight	●		●	●	●			●	●	●	
Delta Wing Glider						●	●				●
Rotor Motor	●								●	●	
Making Time Fly		●		●			●				
Where is North?	●							●			●
Let's Build a Table Top Airport		●	●				●				●
Plan to Fly There		●	●				●				

Science Process Skills



Aerospace Technology Enterprise

The NASA Aerospace Technology Enterprise's charter is to pioneer advanced technologies that will meet the challenges facing air and space transportation, maintain U.S. national security and pre-eminence in aerospace technology, and extend the benefit of our innovations throughout our society.

To benefit fully from the revolution in communication and information technology, we also need a revolution in mobility. To open the space frontier to new levels of exploration and commercial endeavor, we must reduce cost and increase the reliability and safety of space transportation. Both the economy and our quality of life depend on a safe, environmentally friendly air transportation system that continues to meet the demand for rapid, reliable, and affordable movement of people and goods.

Working with our partners in industry, Government, and academia, we have developed four bold goals to sustain future U.S. leadership in civil aeronautics and space transportation. These goals are as follows:

- revolutionize aviation;
- advance space transportation;
- pioneer technology innovation; and
- commercialize technology.

Revolutionize Aviation

NASA's goal to revolutionize aviation will enable the safe, environmentally friendly expansion of aviation in the following areas:

- Increase safety—Make a safe air transportation system even safer by reducing the aircraft accident rate by a factor of 5 within 10 years and by a factor of 10 within 25 years.
- Reduce emissions—Protect local air quality and our global climate.
- Reduce NO_x emissions of future aircraft by 70 percent within 10 years and by 80 percent within 25 years (from the 1996 ICAO Standard for NO_x as the baseline).
- Reduce CO₂ emissions of future aircraft by 25 percent and by 50 percent, respectively, in the same timeframes (from 1997 subsonic aircraft technology as the baseline).
- Reduce noise—Lower the perceived noise levels of future aircraft by a factor of 2 (10 decibels) within 10 years, and by a factor of 4 (20 decibels) within 25 years. The baseline is 1997 subsonic aircraft technology. The word “perceived” is key to the intended interpretation of this noise reduction goal. In subjective acoustics, a 10-dB reduction is perceived as “half” as loud, hence, the stated interpretation of the goal.
- Increase capacity—Enable the movement of more air passengers with fewer delays.
- Double the aviation system capacity within 10 years and triple it within 25 years. The baseline is 1997 levels.
- Increase mobility—Enable people to travel faster and farther, anywhere, anytime.
- Reduce intercity door-to-door transportation time by half in 10 years and by two-thirds in 25 years.
- Reduce long-haul transcontinental travel time by half within 25 years.

Advance Space Transportation

NASA's goal to advance space transportation is to create a safe, affordable highway through the air and into space.

- Mission safety—Radically improve the safety and reliability of space launch systems. Reduce the incidence of crew loss to less than 1 in 10,000 missions (a factor of 40) by 2010 and to less than 1 in 1,000,000 missions (a factor of 100) by 2025.
- Mission affordability—Create an economical highway to space.
- Reduce the cost of delivering a payload to low-Earth orbit (LEO) to \$1,000 per pound (a factor of 10) by 2010 and to \$100 per pound (an additional factor of 10) by 2025.
- Reduce the cost of interorbital transfer by a factor of 10 within 15 years and by an additional factor of 10 by 2025.
- Mission reach—Extend our reach in space with faster travel. Reduce the time for planetary missions by a factor of 2 within 15 years and by a factor of 10 within 25 years.

Pioneer Technology Innovation

NASA's goal to pioneer technology innovation is to enable a revolution in aerospace systems.

- Engineering innovation—Enable rapid, high-confidence, and cost-efficient design of revolutionary systems.
- Within 10 years, demonstrate advanced, full-life-cycle design and simulation tools, processes, and virtual environments in critical NASA engineering applications.
- Within 25 years, demonstrate an integrated, high-confidence engineering environment that fully simulates advanced aerospace systems, their environments, and their missions.
- Technology innovation—Enable fundamentally new aerospace system capabilities and missions.
- Within 10 years, integrate revolutionary technologies to explore fundamentally new aerospace system capabilities and missions.
- Within 25 years, demonstrate new aerospace capabilities and new mission concepts in flight.

Commercialize Technology

The NASA Commercial Technology Program enables the transfer of NASA technologies to the private sector to create jobs, improve productivity, and increase U.S. competitiveness. NASA provides assistance to a wide variety of companies, with special emphasis on small businesses.



Aeronautics

Background for Educators

“Birds fly, so why can’t I?” That question was probably first asked by cave dwellers watching a bird swoop through the air. Perhaps even then, people understood the advantages of human flight. The desire to defy gravity and experience the freedom of flight compelled early attempts to unravel the mysterious technique the birds had mastered proficiently.

Piloted flight and the mobility it offered to humankind would have to wait many centuries. The more immediate goal of the cave dwellers was survival. The discovery of fire by early inhabitants helped assure a permanent place on Earth for descendants. While a small spark eventually produced the light and heat of fire, the spark for flight was imagination. Ironically, the discovery of fire would play a major role in our first flight. Fire and flight forever changed the way we lived.

The writings and voices of past civilizations provide a record of an obsession with flight. The aerial dreams of early writers are revealed in Roman and Greek mythology. The mythical father and son team of Daedalus and Icarus used artificial wings of wax and bird feathers to escape from Crete. In Greek mythology, Pegasus was a winged horse. Some writings contributed significantly to the emerging science. From the early 1480’s until his death in 1519, the Florentine artist, engineer, and scientist, Leonardo da Vinci, dreamed of flight and produced the first drawings for an airplane, helicopter, *ornithopter*, and parachute.

In the early 17th century, serious aeronautical research was conducted by so-called “birdmen” and “wing flappers.” These early experimenters were erroneously convinced that wings strapped to a human body and muscle power were the answer to flight. Their daring and often dangerous experiments made scant contributions to aeronautical knowledge or progress. By the mid-17th century, serious-minded experimenters had correctly decided that

humans would never duplicate bird flight. They turned their attention to finding a device that would lift them into the air.

Two French paper makers, Joseph and Etienne Montgolfier, noting the way smoke from a fire lifted pieces of charred paper into the air, began experimenting with paper bags. They held paper bags, open end downward, over a fire for a while and then released them. The smoke-filled bags promptly ascended upward. Smoke, the brothers deduced, created a lifting force for would-be flyers. Scientists would later explain that when air is heated, it becomes less dense, thus creating a buoyant or lifting force in the surrounding cool air.

On September 19, 1783, a sheep, a rooster, and a duck were suspended in a basket beneath a Montgolfier balloon. The cloth and paper balloon was 17 meters high, and 12 meters in diameter. A fire was lit, and minutes later the balloon was filled with hot air; it rose majestically to a height of more than 500 meters. The farm animals survived the ordeal and became the first living creatures carried aloft in a human-made device. The dream of flight was now the reality of flight. Two months later on November 21, 1793, two volunteers stepped into the basket and flew for eight kilometers over Paris, thereby becoming the world’s first aeronauts. Flying became practical in lighter-than-air devices, and balloon mania set in.

Throughout the 19th century, *aeronauts* experimented with hydrogen gas-filled balloons and struggled to devise a method to control them. After another century of experimenting, the balloon had become elongated and fitted with propulsion and steering gear. Ballooning had become a fashionable sport for the rich, a platform for daring circus acts, and provided valuable observation posts for the military. Yet none of this was flying the way birds fly – fast, exciting, darting, diving, and soaring with no more than an effortless flick of wings. To escape the limitations of a floating craft, early researchers began the search for another, more exciting form of lift.

A small but dedicated handful of pioneers were convinced that the future of human flight depended



more on wings and less on smoke and hot air. One of these early pioneers had an intense interest in the flight of birds and became obsessed with ways its principles might be adapted by humans. As early as 1796, Englishman George Cayley conducted basic research on *aerodynamics* by attaching bird feathers to a rotating shaft, thereby building and flying a model helicopter. In 1804, he built and flew the world's first fixed-wing flyable model glider. This pioneering model used a paper kite wing mounted on a slender wooden pole. A tail was supported at the rear of the pole providing horizontal and vertical control. It was the first true airplane-like device in history.

In 1849, after years of extensive and persistent research, Cayley constructed his "boy glider." This full-sized heavier-than-air craft lifted a 10 year old boy a few meters off the ground during two test runs. Four years later, Sir George Cayley persuaded his faithful coachman to climb aboard another glider and make the world's first piloted flight in a fixed-wing glider.

In Germany, Otto Lilienthal believed that arched or curved wings held the secret to the art of flight. In his Berlin workshop, Lilienthal built test equipment to measure the amount of lift that various shapes of wings produced. His work clearly demonstrated the superior lifting quality of the curved wing. By 1894, Lilienthal's unpowered flying machines were achieving spectacular glides of over 300 meters in distance. Lilienthal built a 2 1/2 horsepower carbonic acid gas engine weighing 90 pounds. He was ready to begin powered glider experiments. Unfortunately, Lilienthal was killed in an 1896 glider mishap before he could test his power-driven airplane.

Otto Lilienthal left behind an inspiration and a warning. If his life's work proved that we could fly, then his death was a somber warning. Humans would have to master the aerodynamics of wings before flight like the birds could be accomplished with confidence and safety. His extensive research and experiments in aviation brought the world closer to realizing the age-old dream of human flight.

Lilienthal's work was carried forward by one of his students, a Scotsman named Percy Pilcher. Like Lilienthal, Pilcher built his own four-horsepower engine in hopes of achieving powered flight. Ironically, before he could conduct any experiments with powered flight, Pilcher was killed in a glider accident during 1899.

As the 19th century drew to a close, aviation pioneers continued to probe the mystery surrounding mechanical flight. Octave Chanute, Samuel Langley, and others experimented to produce further understanding of aeronautical principles and knowledge, yet controlled, powered flight was not realized. In 1900, the world waited for a lightweight power source and a method to control flight.

On May 30, 1899 Wilbur Wright wrote to the Smithsonian Institution in Washington, D.C. requesting information about published materials on aeronautics. By early summer of that year, Wilbur and his brother Orville had read everything they could find on the subject. The Wright brothers began a systematic study of the problem of flight by conducting research on the methods tried by previous experimenters. They conducted hundreds of wind tunnel experiments, engine and propeller tests, and glider flights to gain the knowledge and skill needed to fly.

On December 17, 1903, four years after beginning their research, the world was forever changed. A fragile cloth and wood airplane rose into the air from a windswept beach at Kitty Hawk, North Carolina, and flew a distance of 36 meters. The brothers provided the world with a powered flying machine controlled by the person it carried aloft. Ingenuity, persistence, and inventiveness had finally paid a big dividend—the Wright Flyer was successful. This 12-second event marked the beginning of tangible progress in the development of human-carrying, power-driven airplanes.

By 1905, an improved Wright Flyer could fly more than 32 kilometers and stay aloft almost 40 minutes. Five years later, the first international air meet in the United States was held in Los Angeles, California. Glenn Curtiss set a new world's speed record of 88



kilometers per hour and Frenchman Louis Paulhan set an altitude record of 1250 meters. At the outbreak of World War I, the airplane could fly at speeds of over 200 kilometers per hour and reach altitudes of 7500 meters.

The Congress of the United States recognized that a new era in transportation was beginning and the changes would have significant impact on human interchange, commerce, foreign relations, and military strategy. Flight research in the United States got a significant boost in 1915. The National Advisory Committee for Aeronautics (NACA) was formed by the United States Congress “to supervise and direct the scientific study of the problems of flight, with a view to their practical solutions.”

By the 1930’s, NACA wind tunnels and flight test investigations led to improvements in aircraft performance and safety. Research produced new *airfoil* or wing shapes and propeller designs that increased the safety and efficiency of airplanes. New engine cowlings and aerodynamic streamlining reduced drag and increased aircraft speed.

Today NACA’s successor, the National Aeronautics and Space Administration (NASA), has a much broader mission. As its name implies, NASA continues research to keep aviation on the cutting edge of technology for airfoils, materials, construction techniques, engines, propellers, air traffic control, agriculture development, electronics, efficiency, and safety. NASA is striving to make airplanes ecologically safe by lessening the sonic boom for aircraft traveling at *supersonic* speeds and developing propulsion systems that use pollutant-free fuel.

On August 17, 1978 near Paris, France, a hot air balloon descended from the sky and landed in a cornfield. Thousands of onlookers watched and cheered as the three crew members stepped down from the Double Eagle II. They had just completed the first nonstop crossing of the Atlantic Ocean in a balloon. Almost two hundred years earlier in 1783, Parisians cheered the Montgolfier brothers as they launched the first hot air balloon. The time span between the two events is filled with flight milestones that have taken humankind from the dream of flight to landing on the moon.

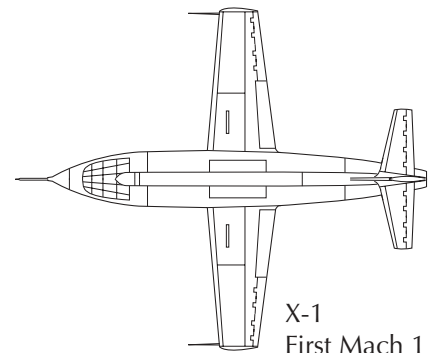

X-1
First Mach 1 Flight
1946-1951

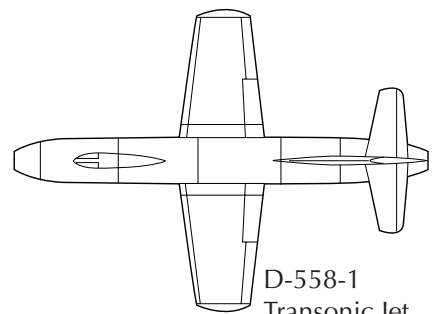

D-558-1
Transonic Jet
1947-1953

Exploring Supersonic Flight

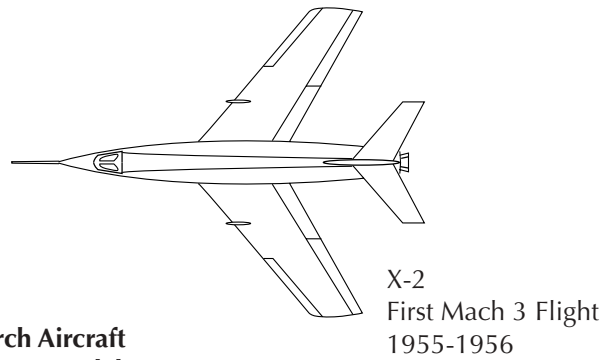
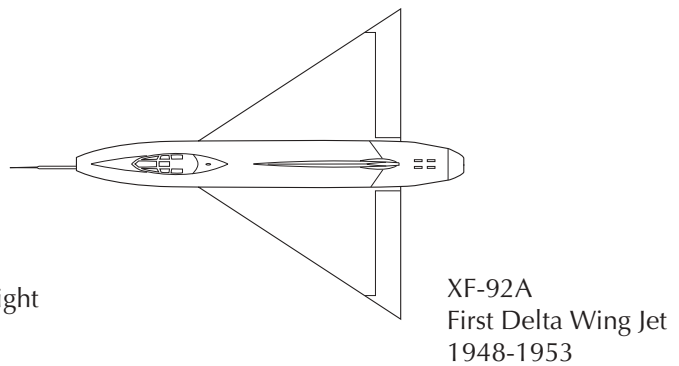
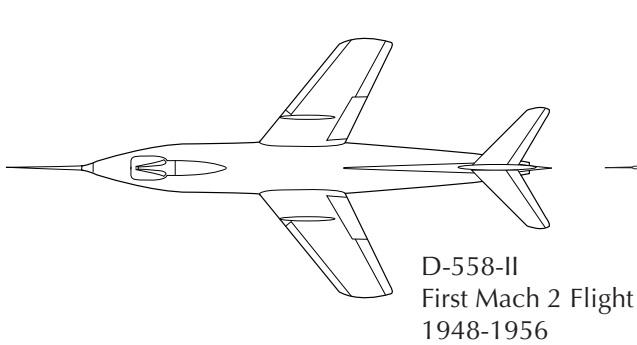
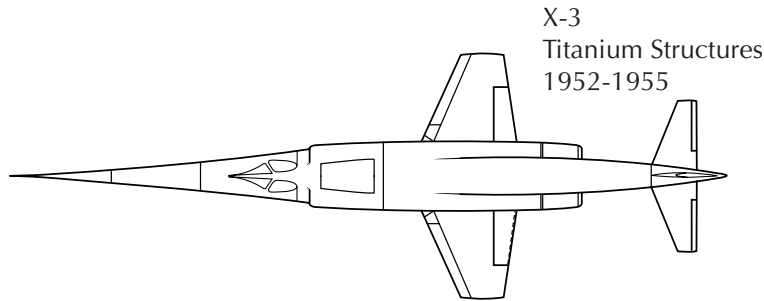
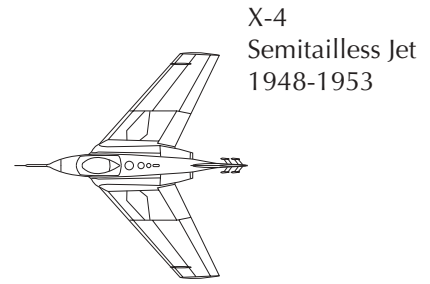

The NACA Experimental Research Aircraft Program which began in the 1940's took human flight to previously unexplored speeds and altitudes.

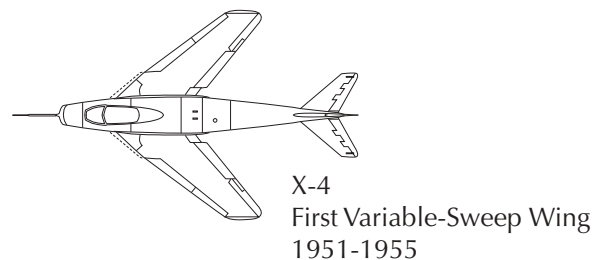

Air

<i>Air Engines</i> -----	12
<i>Dunked Napkin</i> -----	17
<i>Paper Bag Mask</i> -----	23
<i>Wind in Your Socks</i> -----	29
<i>Interdisciplinary Learning Activities</i> -----	36



AIR ENGINES

Objectives

The students will:
Observe how unequal pressure creates power.
Explain that air power can help airplanes fly.
Construct a working model of an air engine.

Standards and Skills

Science

Science as Inquiry
Science and Technology
Position and Motion of Objects

Science Process Skills

Making Models
Observing

Mathematics

Math as Problem Solving
Measurement

Background

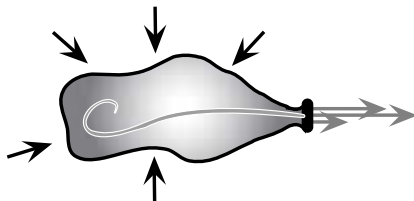
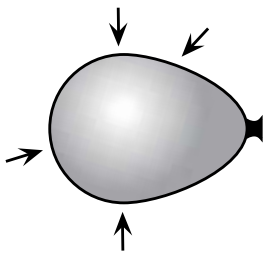

Aircraft powered by jet, piston, or rocket engines are capable of sustained flight. Remaining aloft longer means the aircraft offers greater utility and convenience to users. The aircraft engine provides a constant source of thrust to give the airplane forward movement.

This activity will allow students to build and demonstrate a source of thrust found in some research aircraft: the rocket engine. The straw represents the fuselage and the balloon represents the aircraft engine. Once the balloon is filled with air, there is a difference in air pressure between the outside and the inside of the balloon.

The inside of the balloon has higher pressure than the outside of the balloon. The air on the inside of the balloon equalizes with the air on the outside of the balloon when the balloon is released. Energy is generated as air equalizes from high pressure areas to low pressure areas.



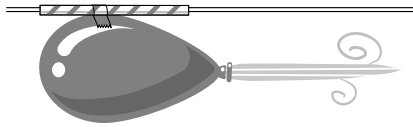

The balloon moves in the opposite direction of the flow of the released air because every action has an opposite and equal reaction. Since the air is released from one small hole, the release of the air is focused in one direction. Because it is focused in one direction, the balloon and straw are forced to move down the string in the opposite direction.

Materials

Balloon
Drinking straw
Fishing line
Tape

Preparation

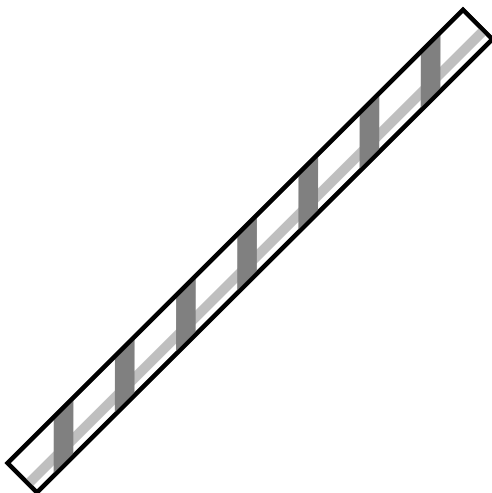

1. Place a drinking straw inside a mystery container. Play a game of 20 questions with the students to see if they can identify what is in the container.
2. Share with them that what is inside has something to do with learning about how airplanes fly. After the students have asked all of the questions, show them the straw inside of the box. Let them know that they will be using the straw to build a model of an air engine.
3. Give the students a few minutes to investigate the straw. Give each student a straw and ask them to describe the straw and see if they can figure out a way to make the straw travel from one place to another (e.g., from the desk to the floor, or from one part of the room to another).

Tell the students that they'll be learning another way to make the straw move—by making an air engine.

Activity

1. Group students in teams of four and provide each team with a set of materials.
2. Have the students inflate a balloon and let it go. Ask the students to make observations about what happened to the balloons when they were released.

Explain to the students that the balloons move because the air pressure on the outside and the inside is different. Have the students observe how the balloons go off in all different directions.

The balloons will move. The energy inside the balloon propels it. Tell the students that the movement of the balloon can be directed toward one place.

3. Now have the students assemble their models.

Have the students place the fishing line through the straw. One student will hold one end of the fishing line, and the other end of the fishing line should be tied to the back of a chair. Then, have the students inflate a balloon with air and hold the end tight while another team member tapes the balloon to the straw. Once this is done, the students can release the balloon nozzle, and observe the balloon (air engine) as it moves across the fishing line.

Have each team tape their engine parts (straw, balloon, and fishing line) to a piece of paper. Have the students use this to explain how the activity worked.

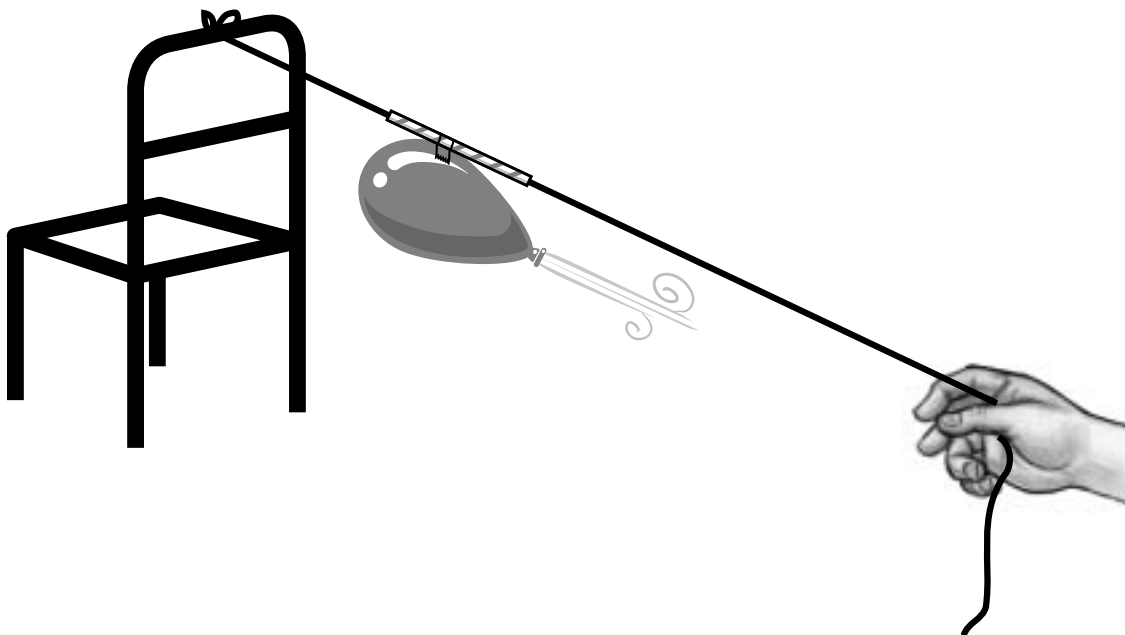

Discussion

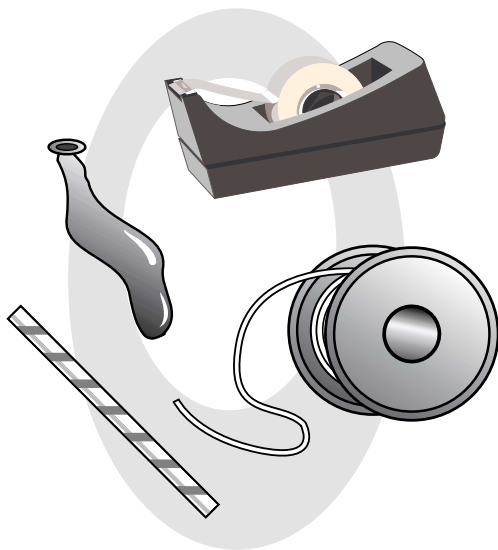

1. Have the students identify the different parts of the air engine model: straw (fuselage), balloon (air engine), fishing line (track).
2. Ask the students to explain why the straw moved along the string. *The balloon moves along the string when the air pressure inside the balloon escapes out of the nozzle. Since the balloon is taped to the straw, the straw moves with the balloon when the air is released.* Help the students make the connections between this and airplanes moving through the air.
3. Ask the students to tell how moving the balloon along the string is different from how they tried moving the straw in the pre-activity. *In the pre-activity, students did not use directed air pressure to move the straw. They moved the straw by throwing it or dropping it. In the air engine activity, the students move the straw when they focus the air power.*

Assessment

Have the students make a drawing of their air engines, and then write or tell about how the air engine worked.

Have the students write how air power helps airplanes fly.

Extensions

1. Have the students construct another air engine model, but this time let them investigate with different sizes and shapes of balloons.
2. Have the students make a longer track and record the distance the engine moves the straw along the track.
3. Have the students make a vertical track and observe how the air engine moves the straw from the floor to the ceiling.
4. Hold air engine contests to see which team can make the air engine straw go the farthest distance.



Air Engines

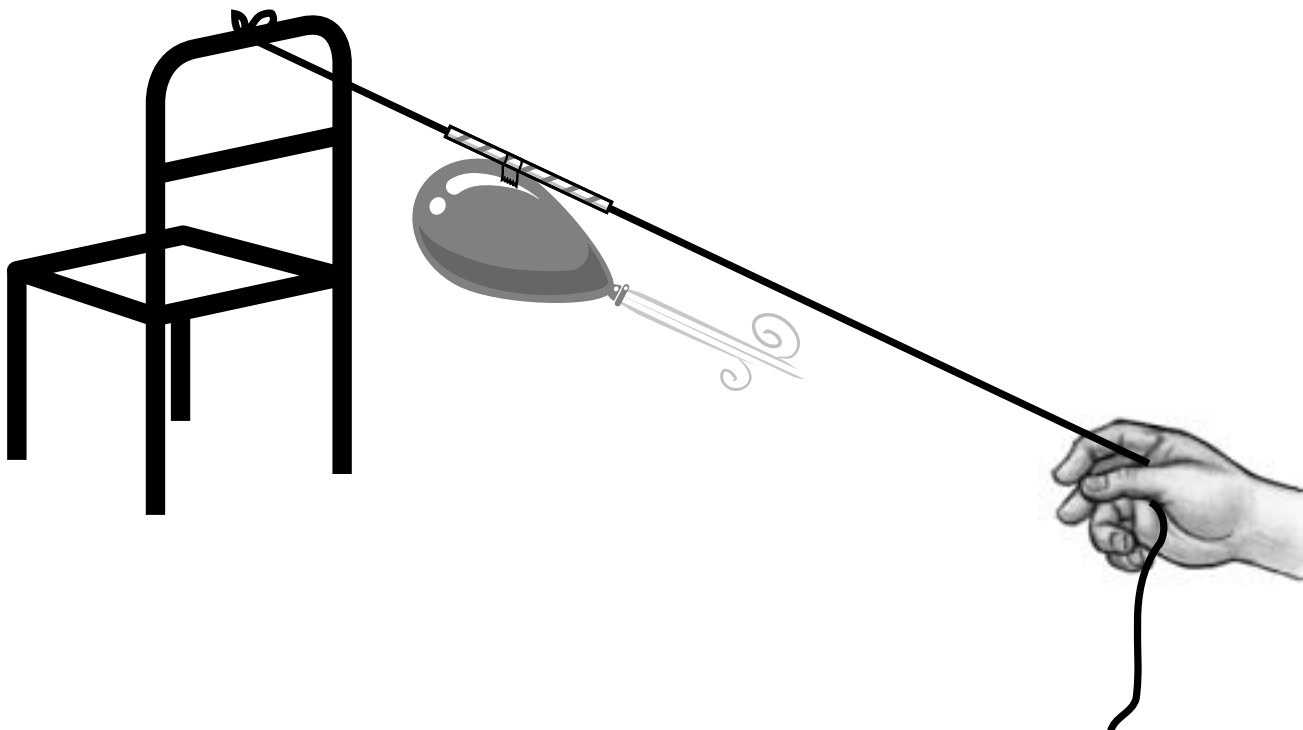
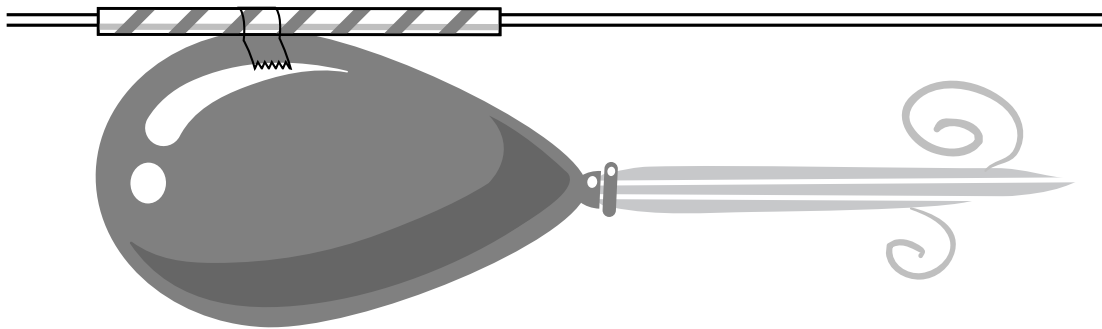
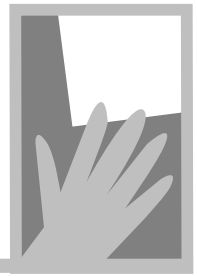

DUNKED NAPKIN

Objectives

The students will:
Experiment to determine if air occupies space.

Standards and Skills

Science

Science as Inquiry
Physical Science
Properties of Objects and Materials
Evidence, Models, and Explanations

Mathematics

Verifying and Interpreting Results

Science Process Skills

Predicting
Observing
Investigating
Interpreting Data

Background

Gas, solid, and liquid are states of matter found on Earth. One of the basic characteristics of matter is that it occupies space. An observer can "see" a glass of milk sitting on a table. The milk and table are objects that occupy a measurable part of the total volume or space in the room.

Although air is present in the room with other matter, a visual aid is necessary for an observer to "see" that air occupies a portion of space as well. In this experiment a plastic cup containing air and a crumpled napkin are turned upside down and placed into a container of water. Air and water cannot occupy the same space at the same time, therefore the napkin remains dry.



When conducting scientific inquiry, scientists begin by asking questions about why something is a certain way. In this case, "does air take up space?" Based on the question, they predict what the answer is. This is called forming a *hypothesis*.

The next step is to test the hypothesis with an experiment. Scientists draw *conclusions* from the results of their experiment, which leads them to either accept or reject their hypothesis.

Materials

Clear plastic cup
Napkin
Water
Basin or small aquarium
Newspapers or drop cloth
Balloon

Warm-up

Have students discuss what they think air is. Which of the five senses lets them experience air? Can you taste or smell air? *Probably not.* Can they see it? *No, but you can see things like a wind sock blow in the wind.*

Can you feel air? *Try holding your hand over a heating vent, fanning your face with a folded paper fan, or whirling around with a paper lunch bag on your arm. You might not be able to see air, but you can feel air molecules moving.*

Does air take up space? To help students answer this question, take a deflated balloon and blow air into it so it is partly filled. Ask them what is in the balloon and then blow up the balloon until it is full. Is there more air in the balloon now than there was before? *Obviously air takes up space.*

The balloon has air in it, but does the cup? In this exercise have students predict if there is air in the cup and what will happen to a napkin inside the cup if you put the cup in the basin of water.



Management

This activity can be done as a teacher demonstration or student activity. It will take about 15 minutes to complete and there is a potential for water spillage. Students can work individually or in pairs.

Activity

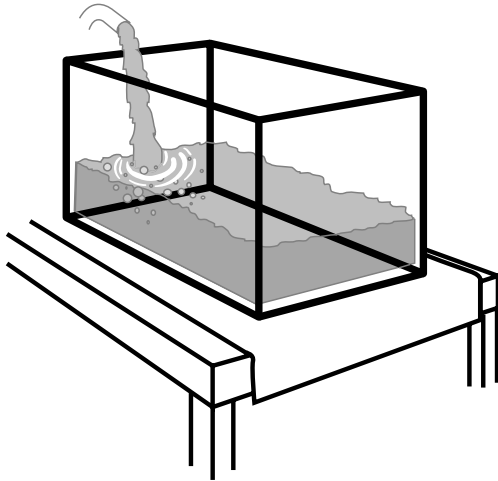

1. Prepare a table for water spillage by covering it with newspapers or a drop cloth.
2. Fill an aquarium or other large container with water.
3. Crumple a napkin and stuff it into a plastic cup.
4. Turn the cup upside-down and plunge it completely into the water. Do not tilt the cup.
5. Remove the cup from the water, and extract the napkin.
6. Observe whether the napkin is wet or dry.

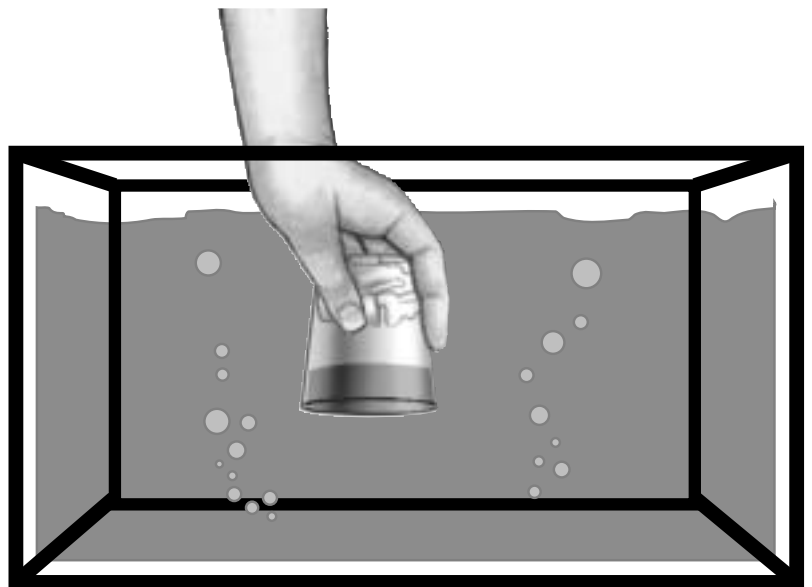

Discussion

1. What is an experiment and why is it conducted? *An experiment is an activity or action designed to answer questions.*
2. What is a hypothesis? *A hypothesis is a proposed answer to a problem, or an explanation that accounts for a set of facts and can be tested by further experimentation and observation. The results of experimentation provide evidence that may or may not support the hypothesis.*
3. What is a conclusion? *A conclusion is an answer based on the experiment.*
4. Why did the napkin stay dry? *Air trapped in the cup with the napkin prevented water from entering the cup.*
5. What is air? *Air is a mixture of gases that make up the Earth's atmosphere.*
6. Can you taste, see, feel, hear, or smell air? *Impurities in air will allow our senses to detect the presence of air. For example, smoke contains particles we can see and smell. Moving air or wind can be felt and heard.*

Assessment

Students will have successfully met the objectives of this activity by:

- Conducting the experiment.
- Stating a conclusion based on the experiment.

Extensions

1. Have the students alter variables like cup size, speed, and angle of insertion and removal, and liquids other than water.
2. Discuss where air pockets can occur: in landfills, underwater or underground caves, capsized canoes, etc.
3. Brainstorm a list of examples of air taking up space that students might see in school, at home, or on television: balloons, bubbles, basketballs, etc.
4. Discuss ways to store air. Space travellers and scuba divers must store air in tanks.





Dunked Napkin

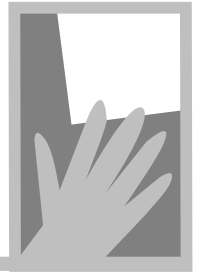

This experiment will help answer the question "Does air take up space?"

Materials: Clear plastic cup, napkin, water, basin or small aquarium, and newspaper or drop cloth

1. Place a drop cloth or newspaper on your work surface. Fill a basin with water.
2. Crumple a napkin and put it at the bottom of the cup. The napkin should fit tightly, and not fall out when the cup is inverted.
3. Predict what will happen to the water and napkin when you turn the cup so that the mouth faces downward and place it in the basin of water.

I predict _____

4. Place the inverted cup into the basin of water. Hold it under water for two minutes and observe what happens.

5. Write or draw what you saw happen to the napkin. _____

6. Carefully pull the cup out of the water and remove the napkin. Is the napkin wet or dry?

7. Can you explain the results of your experiment? _____

8. Use the results of your experiment to answer this question: Does air take up space?





Dunked Napkin

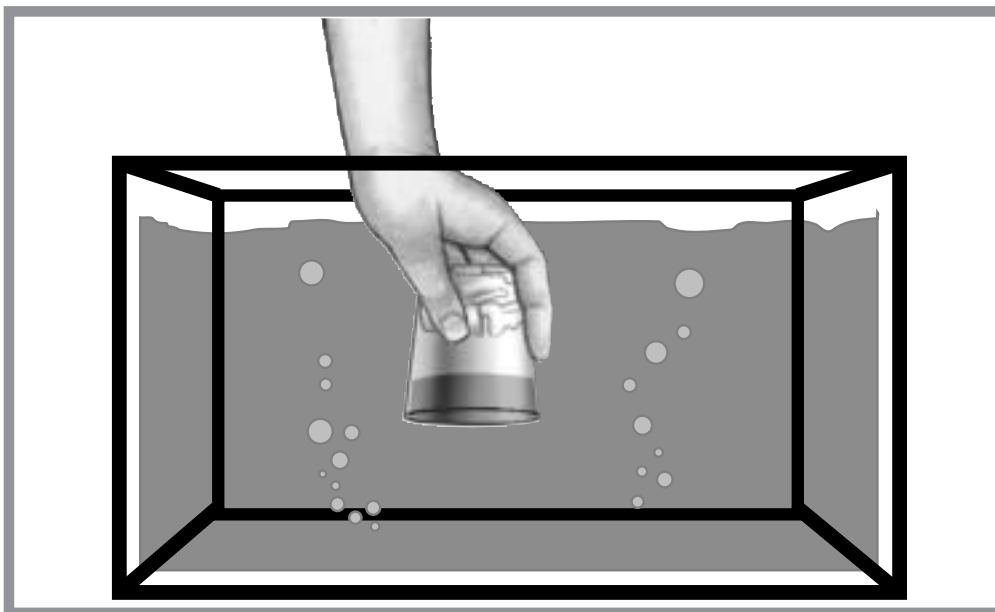
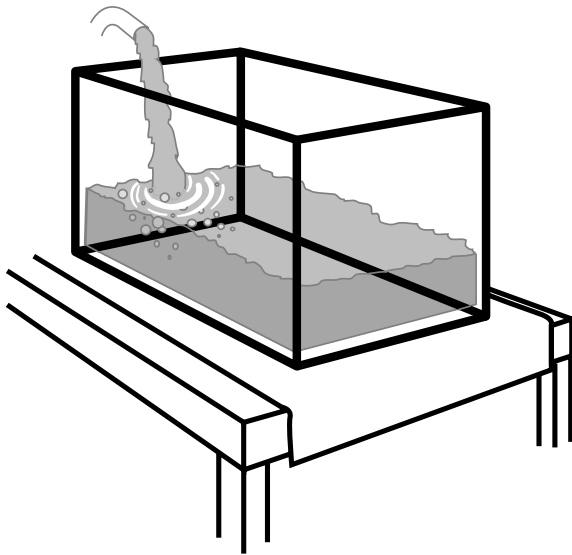
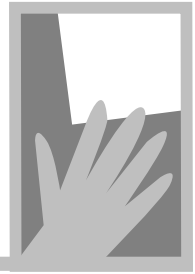

PAPER BAG MASK

Objective

The students will:
Construct a device that demonstrates Bernoulli's principle.
Understand the effect of air flowing over a curved surface.

Standards and skills

Science

Science as Inquiry
Unifying Concepts and Processes

Science Process Skills

Measuring
Inferring
Predicting
Science as Inquiry

Mathematics

Geometry and Measurement
Problem Solving

Background

A change in the speed at which air is flowing will cause a change in air pressure. Daniel Bernoulli, a Swiss scientist in the 18th century, discovered what is now called *Bernoulli's principle*: the pressure in a fluid (gas and liquids) decreases as the speed of the fluid increases.



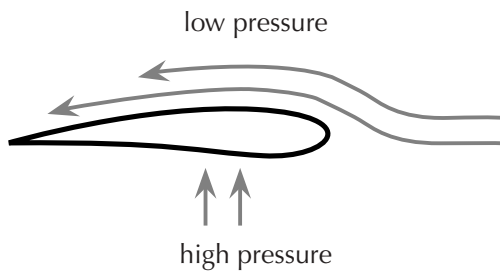

The wing of an airplane is a device that creates changes in the speed of air flow, thus creating a change in air pressure. Air moving over the curved top portion of a wing will travel at higher speed and produce lower pressure than the bottom, creating *lift*. Lift is a force caused by the equalization of pressures. Equalization always occurs from areas of high pressure to low pressure. An inflated balloon has higher air pressure inside than outside. The balloon will pop when the pressure difference becomes too great for the material.

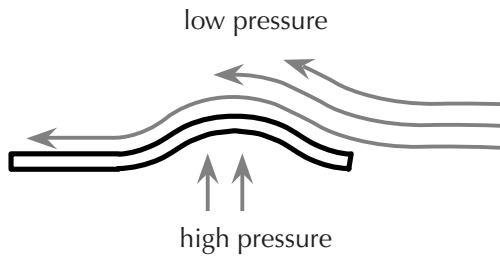

Another example of Bernoulli's principle can be seen using the paper bag mask. When the student blows through the hole in the paper bag mask and over the curved surface of the "tongue," unequal air pressure will lift the tongue.

The low pressure of the airflow over the top of the "tongue" creates lift in the same way that a wing produces lift.

Materials

Large paper grocery bags
Scissors
Crayons or markers
Notebook or copier paper
Tape or glue
Metric ruler

Preparation

Have each student bring a large paper grocery bag from home.

Activity

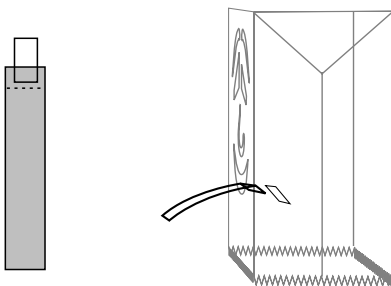
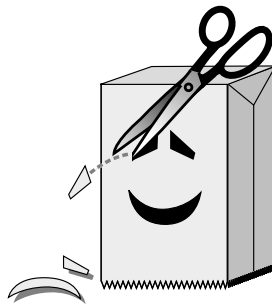
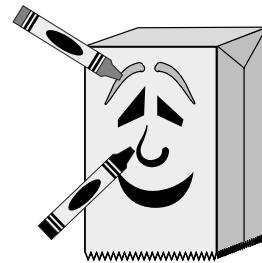
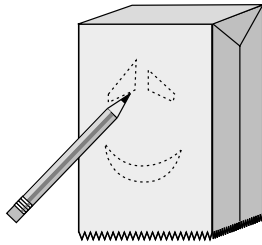

1. Place a bag over the head of one student and have a second student carefully draw small dots where the eyes, nose, and mouth are located.
2. Remove the bag from the head and draw a face around the marks made in step 1.
3. Cut out two holes (approximately 2 cm diameter) for the eyes.
4. Cut a hole (approximately 4 cm diameter) for the mouth.
5. To make the tongue, cut a strip of paper, approximately 3 cm wide and 20 cm long.
6. Tape or glue one end of the tongue inside the bag at the bottom of the mask's mouth. Allow the tongue to droop through the mouth on the outside of the bag.
7. Place the bag over the head and blow through the mouth hole. Observe the movement of the tongue.

Discussion

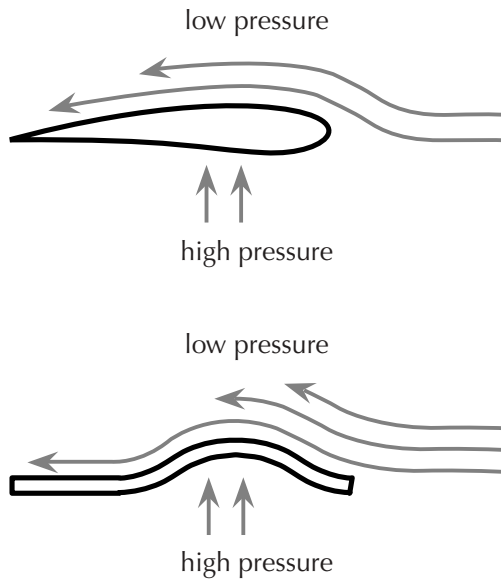

1. Why does the tongue move when you blow gently through the mouth? What happens when you blow harder? The *curved surface of the tongue creates unequal air pressure and a lifting action. Blowing harder will cause the tongue to move up and down faster.*
2. Attach a lightweight streamer to a fan or air conditioning vent. Ask the students to observe and describe what happens. How do the streamers relate to this activity? *The same force moves the tongue and streamers. Lift is caused by air moving over a curved surface.*
3. What are some other common examples of Bernoulli's principle? *Flags waving, sails, an umbrella that becomes impossible to hold in a strong wind.*

Assessment

1. Have a classmate observe the paper tongue and record what happens. Switch roles.
2. Write a paragraph or draw a picture to describe what happens to the paper tongue.
3. Write a paragraph or draw a picture to tell how airplane wings are similar to the paper tongue.

Extensions

1. Experiment with different tongue lengths.
2. Encourage the students to be creative with the designs on the bags – faces that say something about who they are, or who they want to be, maybe the face of a friend, relative, or classmate. The designs may also be abstract, or not human; consider holiday themes.



Paper Bag Mask

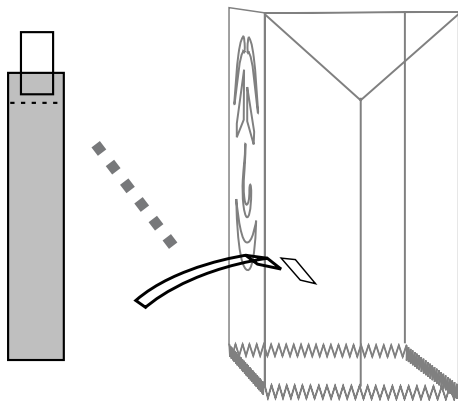
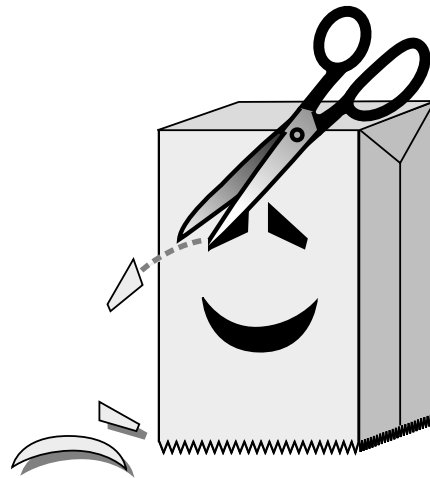
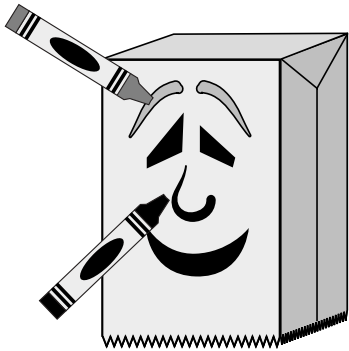
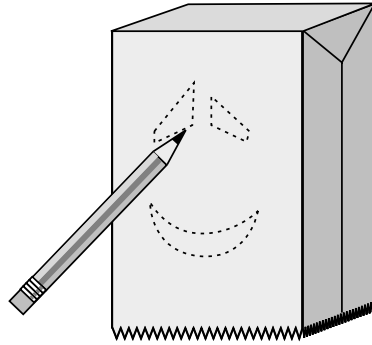
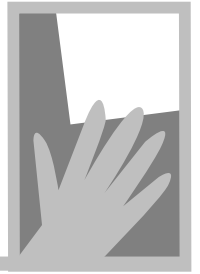



Paper Bag Mask

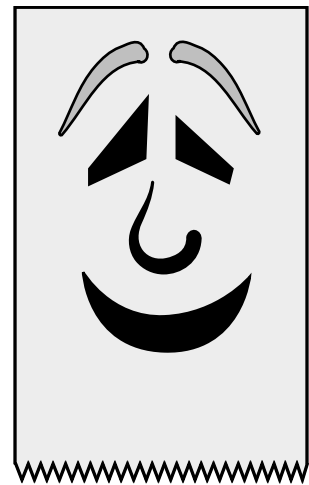
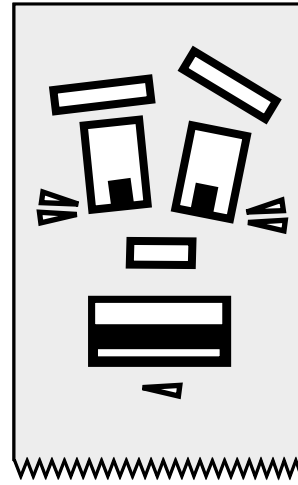
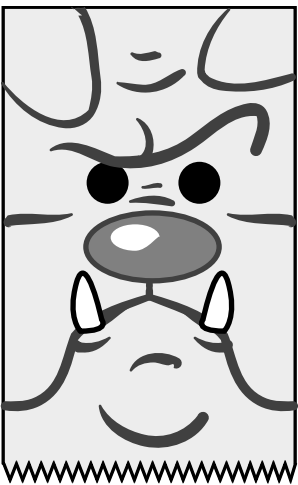
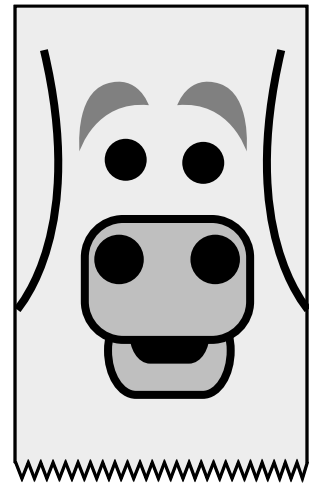
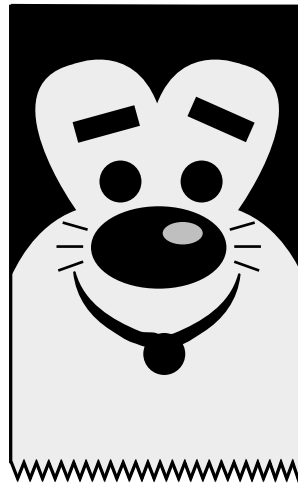
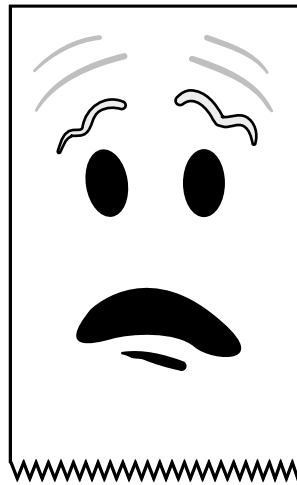
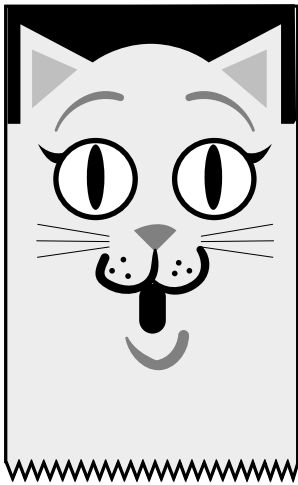
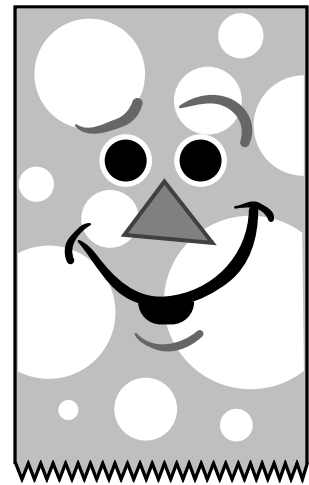
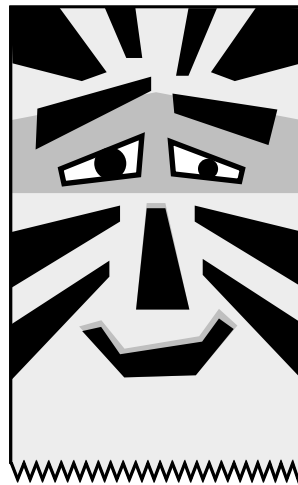
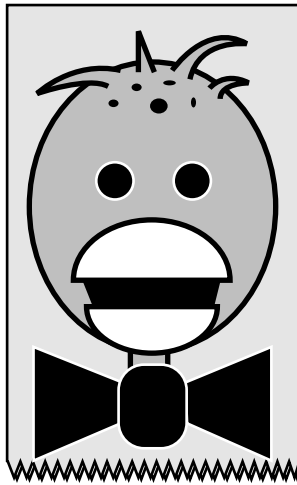
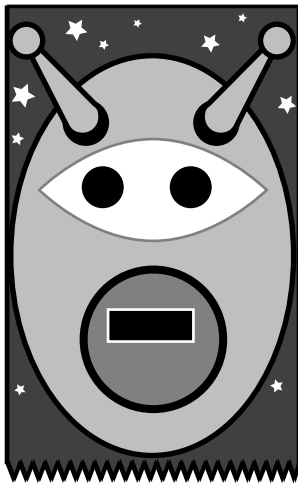
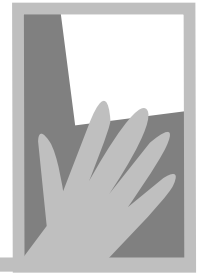

WIND IN YOUR SOCKS

Objectives

The students will:
Construct and use a simple wind sock.
Measure wind direction and speed using a wind sock.

Standards and Skills

Science

Science as Inquiry
Physical Science
Science and Technology

Mathematics

Problem Solving
Reasoning
Measurement

Science Process Skills

Observing
Measuring

Background

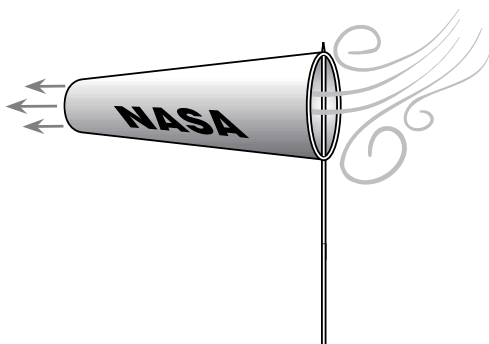

A wind sock is a type of kite used to detect wind direction. It is a tapered tube of cloth that is held open at one end by a stiff ring. Wind is directed down the tube, causing the narrow end to point in the same direction the wind is blowing. Brightly colored wind socks are used at airports to help pilots determine the wind direction along the ground. *Meteorologists* use wind direction to help predict the weather.



Materials

1 sheet 8 1/2 X 11 inch printer or copy paper
1 piece tissue paper 28 cm X 28 cm
White glue or paste
Cellophane tape
Scissors
Single-hole paper puncher
1 Paper clip
Metric ruler
1.2 m kite string
Magnetic compass
Wooden dowel

Preparation

Cut the tissue paper into 28 cm X 28 cm squares before beginning the activity. One square is needed for each wind sock.

Management

The students will need approximately 1 hour to build a wind sock. It can take several days to monitor wind direction. For younger students, make one wind sock for the class and use it to record data on the student page.

Activity

1. Fold a piece of 8 1/2 X 11 inch paper lengthwise to make the border strip for the wind sock.
2. Form a loop from the strip and tape the ends of the paper together. Mark the outside edge with the letter A.

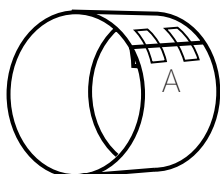
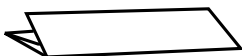
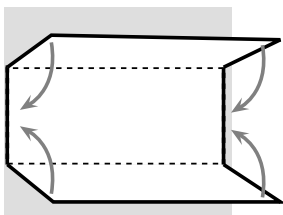

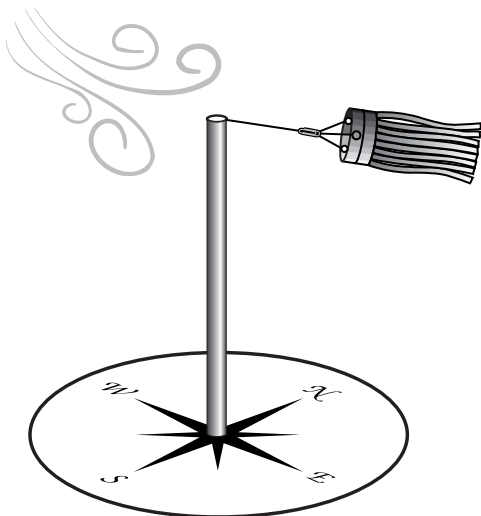
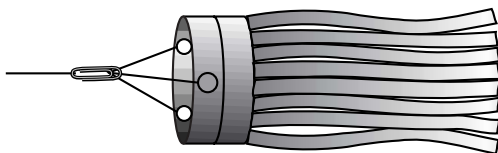
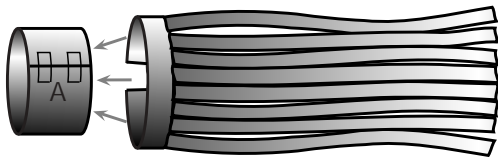
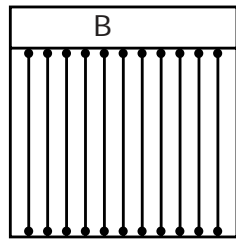
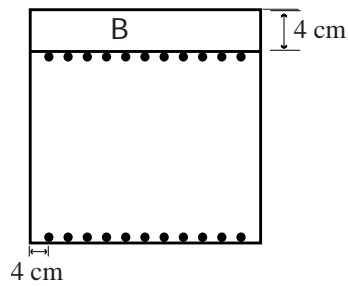

3. On the tissue paper use a marker to draw a line 4 cm from one edge and across the paper. Mark the 4 cm by 28 cm area with the letter B. (Illustrations shown not to scale.)
4. Beginning along one end of the line drawn in part 3 above, measure and mark a point 3 cm from the edge. Continue marking the edge with additional points each separated by a distance of 3 cm.
5. Repeat step 4 to mark points along the opposite end of the tissue paper.
6. Using the points, draw a series of lines on the tissue paper. With scissors, cut along these lines to make strips.
7. Glue edge B of tissue paper to edge A of the loop strip made in step 2. Allow time for the glue to dry.
8. Use a hole punch to punch three holes equal distance around the paper ring.
9. Cut 3 pieces of string 30 cm long. Tie one end of each string to the wind sock at each of the 3 holes.
10. Tie the 3 loose ends of the string to a single paper clip. Add an additional 30 cm length of string to the paper clip.
11. Test the wind sock by holding the single string in front of a fan.
12. Tape the wind sock to a wooden dowel and place outside to monitor wind direction and "speed" (refer to Student Page, the wind sock "speed" gauge determines the strength of the wind, but not actual speed). To help determine wind direction, use a compass to mark north, south, east, and west below the wind sock (with the dowel in the center).

Discussion

1. What does the wind sock do in the wind? *The wind sock aligns itself with the wind and the strips move toward a horizontal position.*
2. What are some ways wind socks can be used? *Pilots preparing for takeoff or landing observe wind socks to determine wind direction and speed, because they want to land and takeoff facing the wind to reduce the takeoff and landing distance. Meteorologists use wind socks to help forecast the weather. Some factories that must regulate the amount emissions they may put into the atmosphere use wind socks monitor wind conditions, wind speed and direction will have an effect upon the distance and direction the emissions will travel.*
3. Discuss how winds get their names (south, northeast, etc.). *They are named for the direction from which they blow. For example, a north wind blows from a northerly direction.*

Assessment

1. Place a fan on a table, then have students demonstrate wind direction using the wind sock.
2. Use the activities on the student pages to determine and record the strength of the wind: calm, a slight breeze, gentle breeze, moderate breeze, or strong breeze.

Extensions

1. Use garbage bags or nylon fabric instead of tissue paper to make a wind sock that is more weather resistant.
2. Use different colors of tissue paper to decorate wind socks
3. Make wind socks of different sizes.
4. Place a wind sock in the classroom in different positions and ask the students to determine if there is air circulation in the room, and from which direction.
5. Ask the students to write down information about the wind on a specific day and time. Repeat this activity for several days.
6. In the classroom, obstruct the airflow (using objects, or students) between the fan and the wind sock and observe how the wind sock responds. Discuss how objects in nature may change the flow of wind.
7. Put the wind sock at different distances from the fan throughout the classroom. Ask the students to observe the various ways the wind sock responds.





Wind in Your Socks

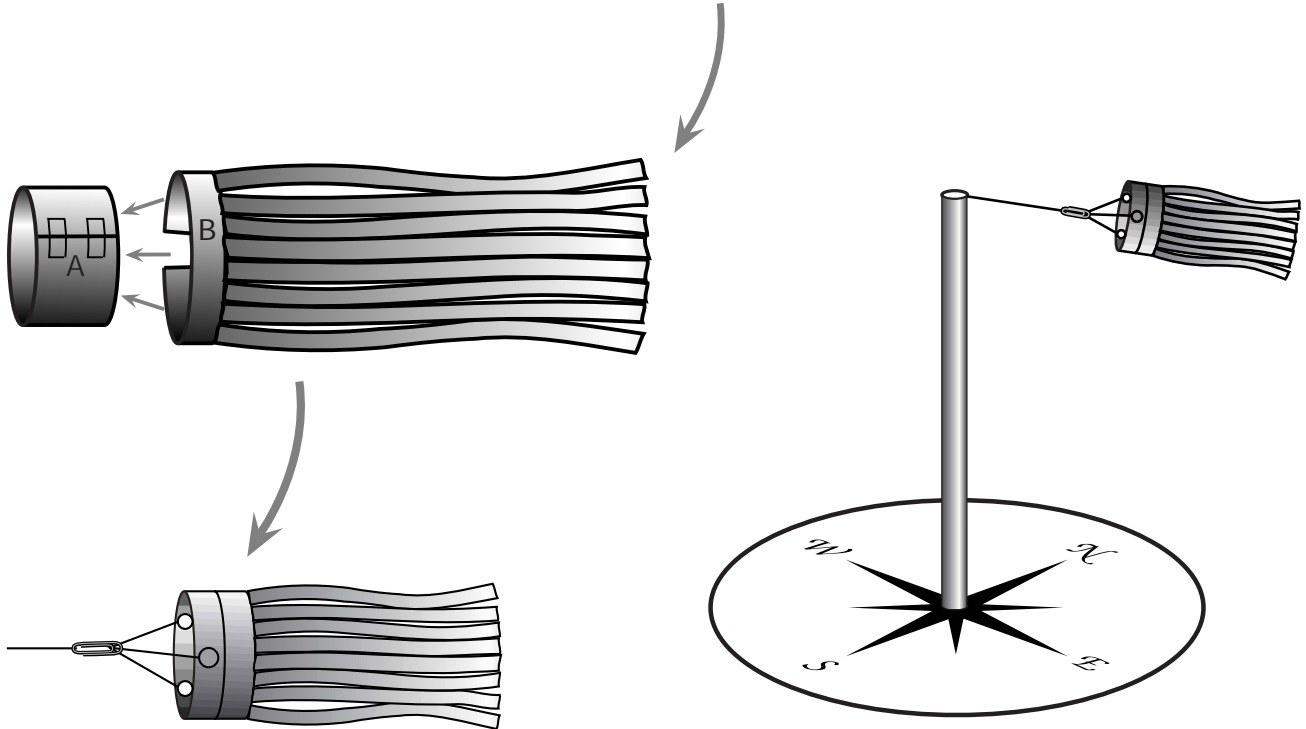
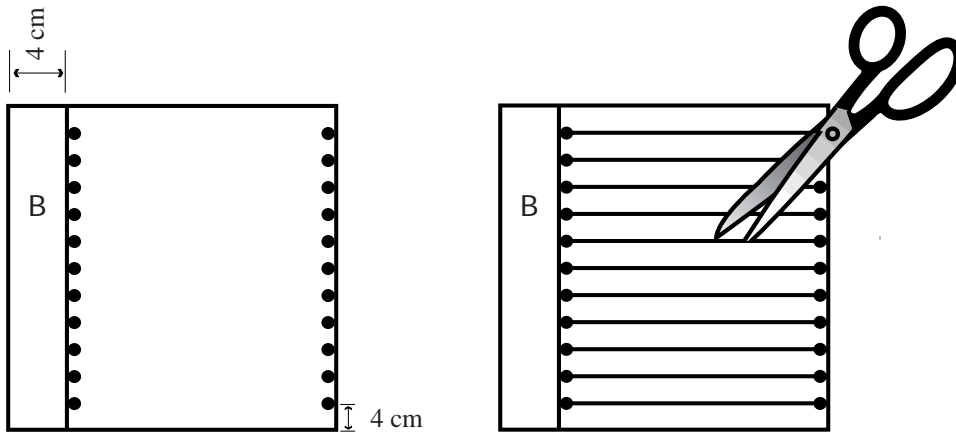
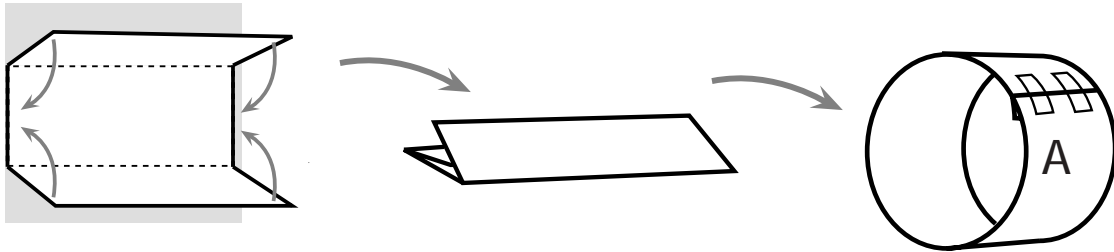
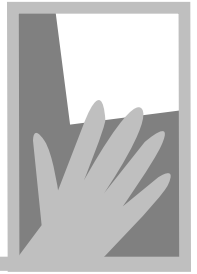



Wind in Your Socks

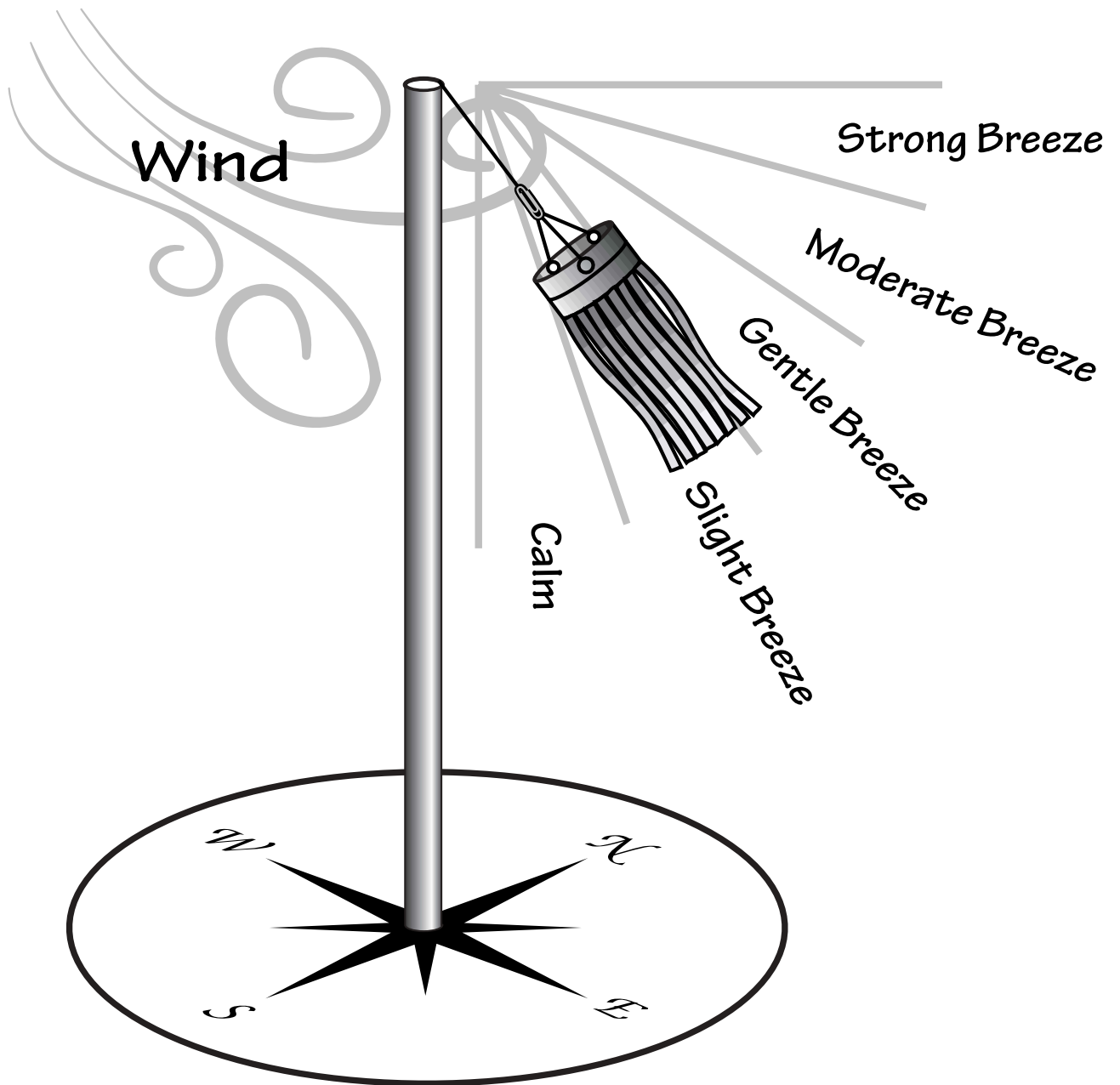
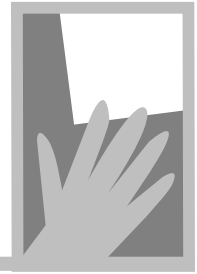



Wind in Your Socks

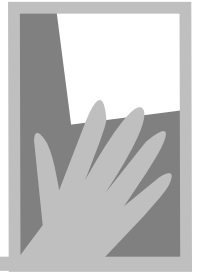

Using your wind sock, record the following information. Color the charts to show the correct wind strength and direction.

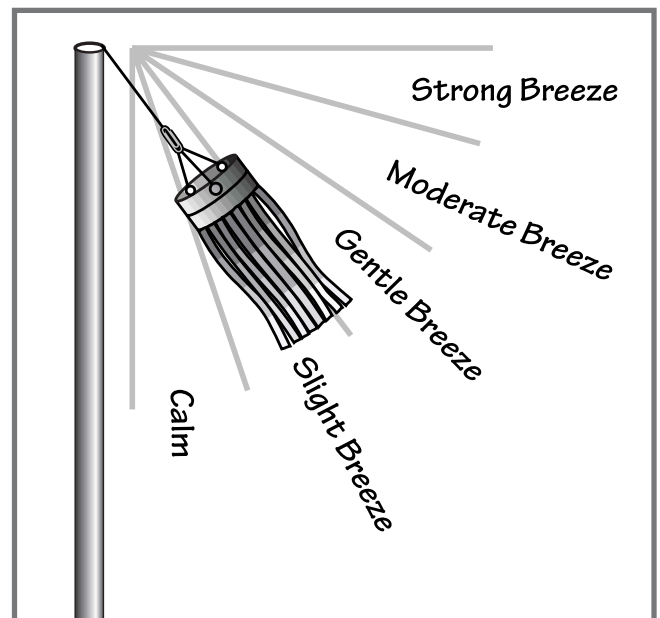
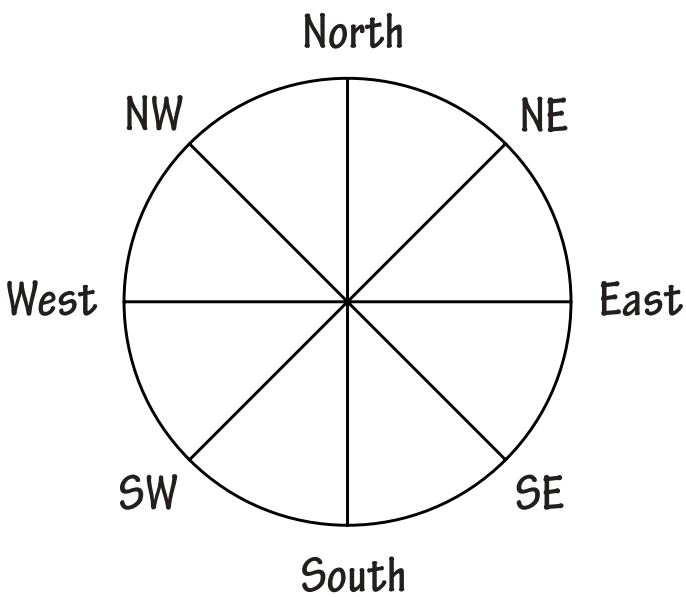

Day:

Time:

Weather:

How is the weather related to the wind strength and wind direction?



Air

INTERDISCIPLINARY LEARNING ACTIVITIES

Science

- Show that an empty, clear plastic soda bottle is not really empty but full of air. Place it under water and observe the air bubbles that come out of the opening.
- Identify objects that are full of air.
- Explain that a wind or breeze is really the movement of air.
- Discuss what would happen to Earth if it were not surrounded by air.
- Research other planets and moons in our solar system that have some type of air (atmosphere). Could humans live there? Does weather exist there?
- Collect a variety of natural and synthetic objects. By tossing and dropping the objects, test which ones stay in the air the longest. Discuss why certain objects “float” longer than others.
- Observe clouds forming. Point out that clouds are formed by changes in temperature and the motion of air.
- Watch weather information broadcasts at home or school. Record the wind information for your locality for a week, also record the type of weather (hot, cold, stormy, rainy, etc.). Discuss the relationship between wind and the rest of the weather for the week.

Mathematics

- Measure how much a student can inflate a balloon with one breath of air. Measure the balloon’s circumference after each breath.
- Fill up various sizes of balloons with air and determine which balloon stays in the air longer when released. Discuss why.
- Count the number of breaths it takes to inflate a balloon. Compare that number with other students in the class. Graph and discuss the results.



Fine Arts

- Draw pictures of how things look when the wind (air) blows across them (examples: trees bend, leaves float, lakes become wavy).
- Make paper spirals and hang them in the classroom. The spirals will move with the air currents in the room.
- Discuss musical instruments that use the force of air (wind instruments such as flute, saxophone, oboe, horn, and harmonica).

Technology Education

- Design a kite, parachute, or parasail using household items.
- Invent and build an air-driven device using household items.
- Explore objects and materials you can use to move air, such as paper fans, straws, and pinwheels.
- Determine what devices move air in your home and your school (examples may include air conditioners, heaters, fans in computers and other equipment).

Social Studies

- Make a collage showing objects and machines from different cultures that harness the power of air.
- Invite a person whose job deals with air, such as a meteorologist or a pilot, to speak to the class about his or her profession.



Language Arts

- Read about and discuss air as a force in fantasy, such as in books like *The Three Little Pigs*, *The Wizard of Oz*, *Alberto and the Wind*, and *A Windy Day*. Compare air in fact and fantasy.
- Keep a journal for a week or two that keeps record of the direction and force of the wind near your home and/or school. Also add temperature and air quality. Do different types of weather come from different directions?
- Write a story about what happens on a very windy day.
- Write a letter to local meteorologists asking questions about air and weather.

Health/Physical Education

Try different ways to feel the air:

- Run with streamers.
- Place a paper bag on your arm and move your arm back and forth.
- Use a small parachute in the school gymnasium to observe how it slows down falling objects.



Flight

<i>Bag Balloons</i>	40
<i>Sled Kite</i>	44
<i>Right Flight</i>	52
<i>Delta Wing Glider</i>	60
<i>Rotor Motor</i>	69
<i>Interdisciplinary Learning Activities</i>	76



BAG BALLOONS

Objectives

The students will:
Demonstrate that heat can change air.
Determine that hot air rises.
Construct a working model of a hot air balloon.

Standards and Skills

Science

Science as Inquiry
Science and Technology

Mathematics

Estimation

Science Process Skills
Communicating
Observing

Background

Hot air balloons are one type of aircraft. (The four categories of aircraft are airplanes, gliders, rotorcraft, and hot air balloons.) In this activity, students construct a working model of a hot air balloon.

There are two ways a balloon can rise: it can (1) be filled with a gas that is lighter than air, such as helium, or (2) it can be inflated with air that is heated sufficiently to make it "lighter" than the air outside of the balloon.

Helium is the second-lightest element, and the main sources for helium are natural gas fields (especially those in the states of Texas, Oklahoma, and Kansas). Heating air makes it less dense, rendering it essentially "lighter." Gas balloons and hot air balloons float because they are lighter than the air they displace.



Materials

Plastic bag ("dry cleaners" bag or 5-gallon trash bag)
Paper clips (used for weight)
Small pieces of paper or stickers (decorations)
String
One hair dryer per classroom (heat source)
Party balloons

Preparation

Show students pictures of hot air balloons. Ask the students to share their ideas about how the balloons rise. Also ask students to share what they know about hot air balloons, or what they think about the uses of hot air balloons.

Show the students a helium balloon. Ask the students to share what they think makes the helium balloon rise when you let go of the string.

Activity

1. Divide the class into groups of four, and provide each team with a set of materials.



2. Have the students decorate their plastic bags. Decorations should be small and light, such as small scraps of paper or stickers.

3. Have the students tie a string around the top of the plastic bag.



4. Add paper clips evenly spaced around the bottom of the plastic bag.

5. Have the students hold the plastic bag over the hair dryer (on the high setting) and let the plastic bag fill with hot air.



6. The plastic bag becomes buoyant as it fills with hot air. When the students feel the bag tugging, have them release it. *The hot air inside the balloon is lighter than the air in the classroom and begins to float.*

Discussion

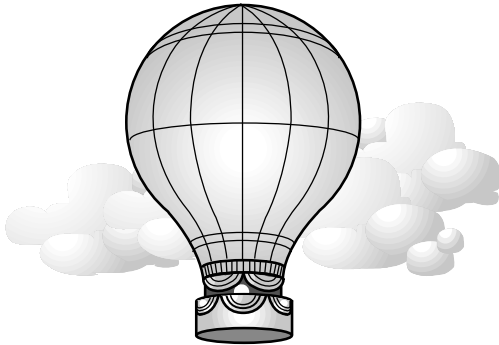

1. Have the students identify the different parts of the hot air balloon: plastic bag—hot air balloon; hair dryer—heat source; paper clips—weights for balance and stability.
2. Ask the students to explain why the hot air balloon works. *The hot air balloon rises when the air inside the balloon becomes heated. The heated air is lighter than the classroom air and enables the balloon to float.*
3. Ask the students to tell how hot air balloons are different from balloons filled with helium. *Helium is a gas that is lighter than air, even when it's not heated. Helium though, just like heated air, floats in the surrounding air because it's lighter. Helium should not be confused with hydrogen, which is an inflammable gas that was often used in balloons and airships until the explosion of the airship Hindenburg in 1937.*
4. Have the students inflate a party balloon. Ask them to explain why it does not rise. *A person's breath may be warmer than room temperature, but it is not hot enough to overcome the weight of the balloon.*

Assessment

Using their actual models, have the students explain why their hot air balloons rise.

Extensions

1. Have the students construct another hot air balloon using different sizes and types of plastic bags.
2. Have students experiment with paper clips—different sizes and numbers—to see the effects of weight on their model balloons.
3. Have the students research the part that balloons played in the history of flight.
4. Have the students role play a reporter interviewing one of the Montgolfier brothers. (Refer to background information included in this guide about the Montgolfier brothers.)





Bag Balloons

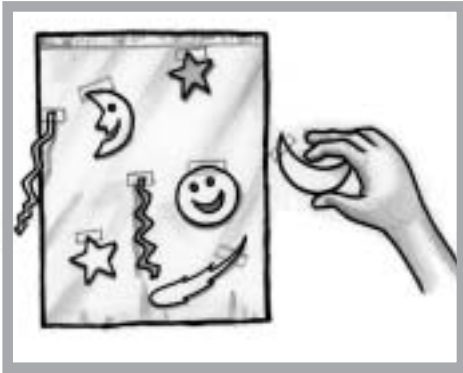
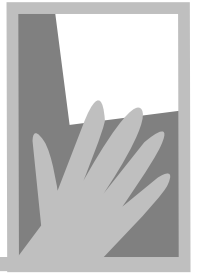

SLED KITE

Objectives

The students will:
Construct and fly a simple sled kite.
Demonstrate how to make the kite fly at varying heights.

Standards and Skills

Science

Science as Inquiry
Unifying Concepts and Processes

Science Process Skills

Observing
Measuring
Predicting
Controlling Variables

Mathematics

Connections
Estimation
Measurement

Background



The sled kite in this activity is a model of a type of airfoil called a parawing. Like any wing, the parawing depends on the movement of air over its shape to generate a lifting force. (Parasails, parafoils, and paragliders are similar lift-generating devices.)

The NASA Paraglider Research Vehicle (Parasev) was the first flight vehicle to use the Francis Regallo-designed parawing. The little glider was built and flown by NASA during the early 1960's to evaluate the parawing concept, and to determine its suitability to replace the parachute landing system on the Gemini spacecraft. Although the parawing was never used on a spacecraft, it revolutionized the sport of hang gliding. Hang gliders use a parawing to glide from cliffs or mountain tops.



There are kites of all shapes, sizes, and colors. The sled kite in this activity is made from a piece of cloth or paper and two drinking straws. The straws are attached parallel to each other on opposite sides of the cloth or paper. This arrangement shapes the kite like a sled when it catches the air. The string attachment points are placed toward one end of the kite, which causes the opposite end to hang downward, and stabilizes the kite in flight.

Materials (per kite)

Sled Kite Template
Two drinking straws
Cellophane tape
Scissors
Two 45 cm lengths of string
One 1 m length of string
Metric ruler
Single-hole paper puncher
One paper clip
Markers, crayons, pencils
Selection of paper (crepe, tissue, newspaper)

Management

Approximately 30 minutes are needed to build the sled kite. Additional time is needed to allow the students to fly and evaluate their sled kites outside.



Activity

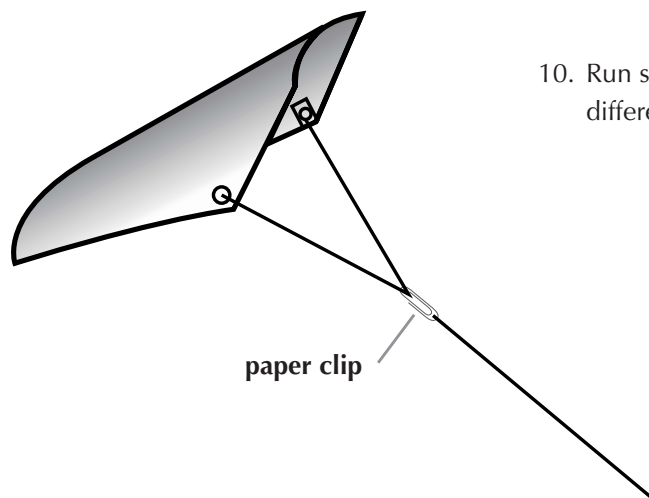
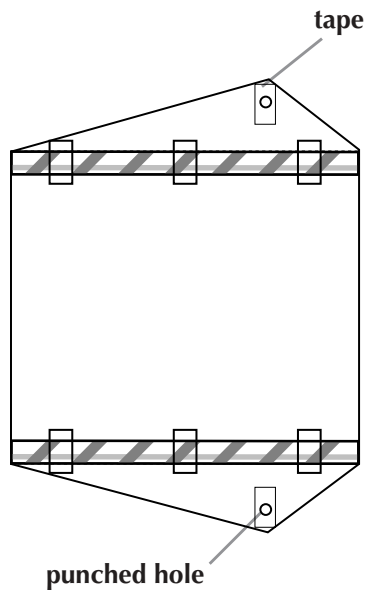
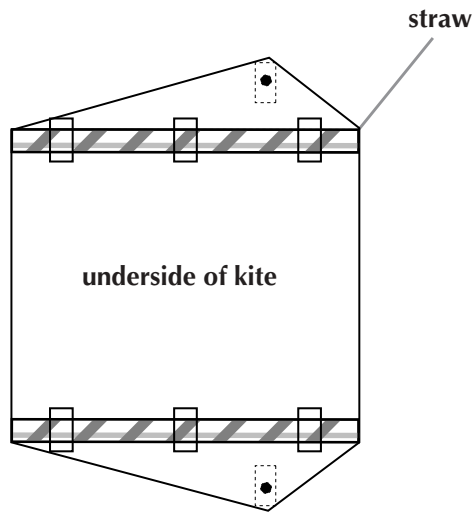

1. Make a copy of the Sled Kite Template. Carefully cut out the sled kite.
2. Decorate the top of the sled kite using crayons, markers, or other media.
3. Trim the length of the two drinking straws so they will fit in the area marked for the straws. Tape them in place.
4. Place two or three pieces of tape in the marked areas covering the black circles.
5. Using a single-hole paper puncher, carefully punch the two holes marked by the black circles.
6. Cut two pieces of kite string 45 cm each. Tie a string through each hole. Tie them tight enough so you do not tear the paper.
7. Tie the opposite end of both strings to a paper clip.
8. Pick up the 1 m long piece of string. Tie one end of this string to the other end of the paper clip. Your sled kite is ready to fly!
9. Outside in a clear area, hold the 1 m length of string and run with the kite to make it fly.
10. Run slow and run fast, and observe how the kite flies at different towing speeds.

Discussion

1. Can kites be used to lift objects? *Yes, a popular beach activity uses a large kite (parasail) towed by a speed boat to lift a person high into the air.*
2. Why are kites made of lightweight material? *Lightweight materials insure the kite will weigh less than the "lift" produced by the kite.*

Assessment

1. Have students explain how their kite was built.
2. Have students demonstrate ways to make the kite fly higher, and to fly lower.

Extensions

1. Have the students decorate their kite using a minimum of three colors.
2. Record the length of time for each flight.
3. Have the students run a relay with a kite as a means to sustain its flight.
4. Design a kite and write the directions on how to build it.
5. Add a tail to the sled kite using crepe paper, strips of newspaper, tissue paper, or garbage bags. Have students predict what, if any, changes will occur in the kite's flight characteristics. Conduct flights to test the predictions.
6. Research the history of kites.



Sled Kite Template

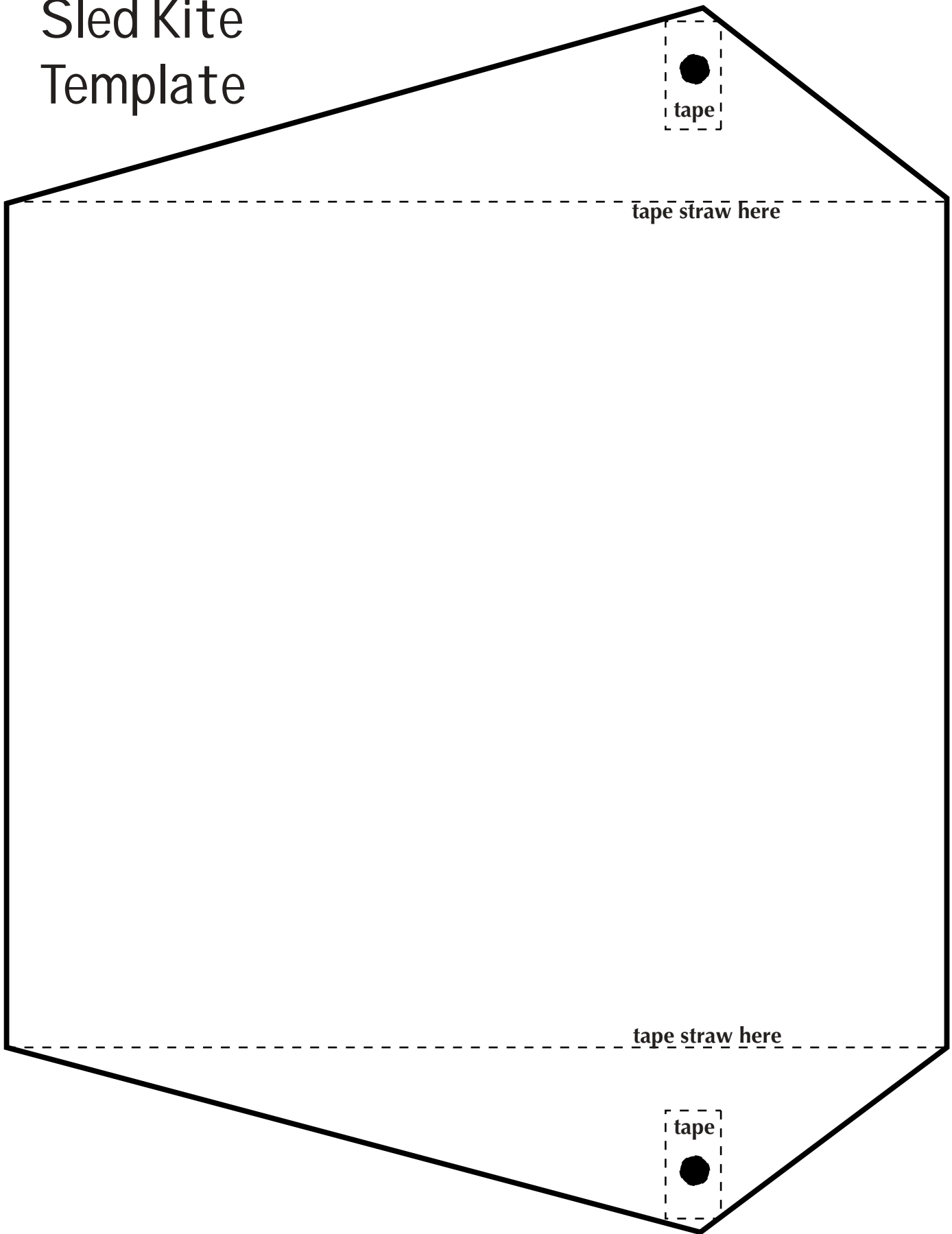



Sled Kite

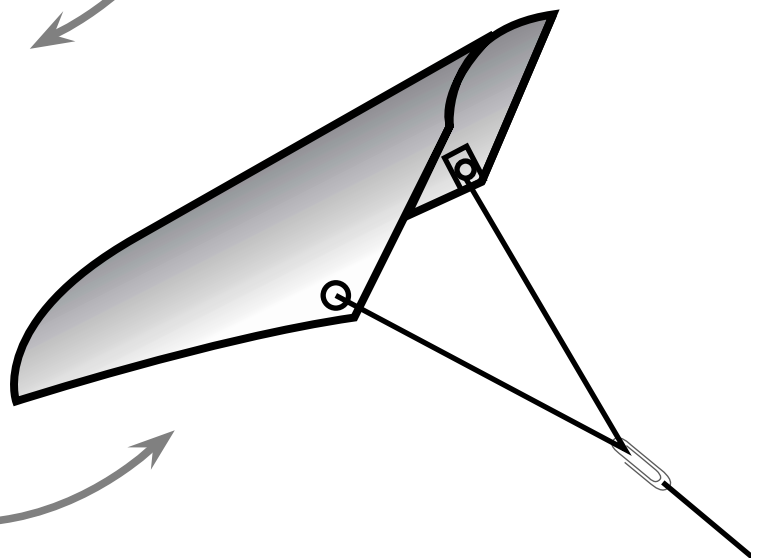
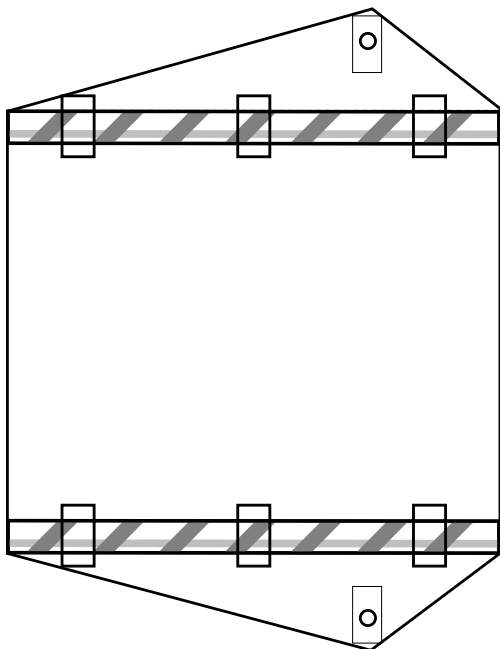
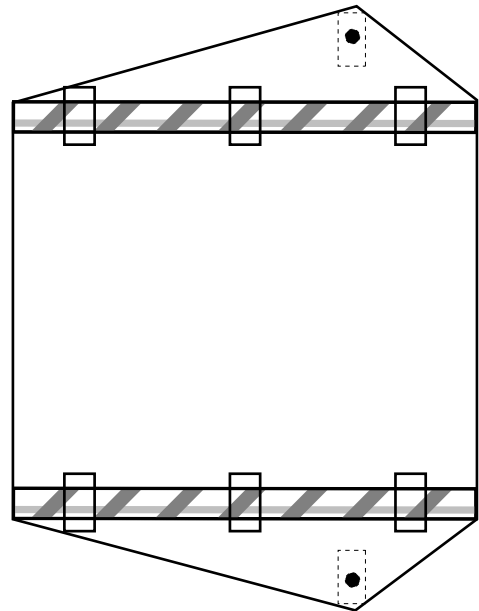
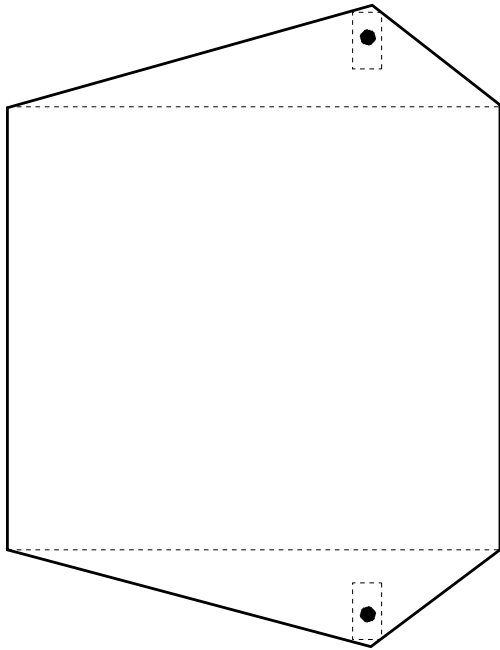
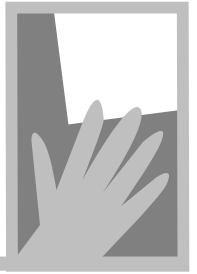



Sled Kite

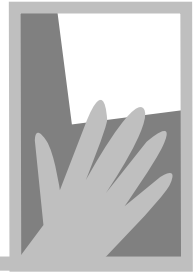



Sled Kite

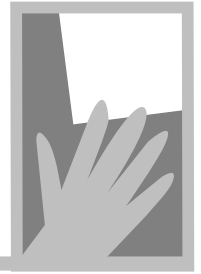

Sled kite flying journal

Date _____ Student name _____

Weather _____

Sled Kite Flight

What happened when I...

1. When I walked with my sled kite, my sled kite:

2. When I ran with my sled kite, my sled kite:

Sled Kite Tail, What if...

What if I add a tail to my sled kite? I think a tail will make my sled kite fly like this:

After I added a tail to my sled kite, it flew like this:

What if I shorten the tail, I think it will make my sled kite fly like this

What if I lengthen the tail, I think it will make my sled kite fly like this:

Conclusions

If the tail is shortened, then the sled kite will fly like this:

If the tail is lengthened, then the sled kite will fly like this:



RIGHT FLIGHT

Objectives

The students will:
Construct a flying model glider.
Determine weight and balance of a glider.

Standards and Skills

Science

Science as Inquiry
Physical Science
Science and Technology
Unifying Concepts and Processes

Science Process Skills

Observing
Measuring
Collecting Data
Inferring
Predicting
Making Models
Controlling Variables

Mathematics

Problem Solving
Reasoning
Prediction
Measurement

Background

On December 17, 1903, two brothers, Wilbur and Orville Wright, became the first humans to fly a controllable, powered airplane. To unravel the mysteries of flight, the Wright brothers built and experimented extensively with model gliders. *Gliders* are airplanes without motors or a power source.



Building and flying model gliders helped the Wright brothers learn and understand the importance of *weight* and *balance* in airplanes. If the weight of the airplane is not positioned properly, the airplane will not fly. For example, too much weight in the front (nose) will cause the airplane to dive toward the ground. The precise balance of a model glider can be determined by varying the location of small weights.

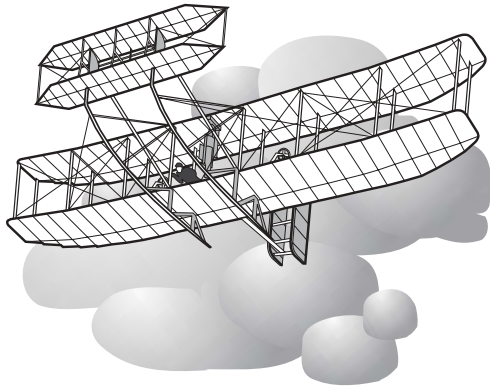

Wright Flyer

Wilbur and Orville also learned that the design of an airplane was very important. Experimenting with models of different designs showed that airplanes fly best when the *wings*, *fuselage*, and *tail* are designed and balanced to interact with each other.

The Wright Flyer was the first airplane to complete a controlled takeoff and landing. To manage flight direction, airplanes use control surfaces. *Elevators* are control surfaces that make the nose of the airplane *pitch* up and down. A *rudder* is used to move the nose left and right. The Wright Flyer used a technique called *wing warping* to begin a turn. On modern airplanes, *ailerons* are used to *roll* the airplane into a turn.

At NASA, model airplanes are used to develop new concepts, create new designs, and test ideas in aviation. Some models fly in the air using remote control, while others are tested in wind tunnels. Information learned from models is an important part of NASA's aeronautical research programs. The goals of NASA research are to make airplanes fly safer, perform better, and become more efficient.

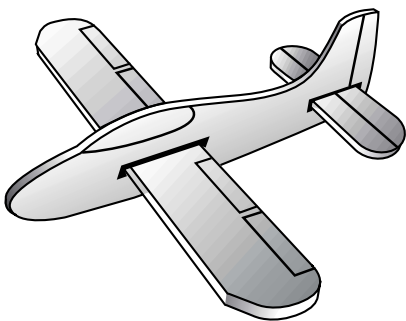

Right Flight Glider

This activity is designed to help students learn about basic aircraft design and to explore the effects of weight and balance on the flight characteristics of a model glider. Students use science process skills to construct and fly the Styrofoam glider.

Management

This activity will take about one hour.

Materials

Styrofoam food tray, size 12
Glider template
Plastic knife
Toothpicks
Sand paper or emery board
Binder clips
Paper clip
Markers
Goggles (eye protection)

Part 1 Building the Glider

Preparation

1. Ask students to name some materials that might be used to build a model glider. *Responses might include balsa wood, paper, cardboard, plastic, and Styrofoam.*
 2. Gently toss a Styrofoam tray into the air and ask the students to describe how the tray "flew." *The tray does not fly because it is not designed to fly. Instead of flying (gliding) it drops.*
 3. Explain to students that Styrofoam is lightweight and strong which makes it an ideal material to construct model gliders. Styrofoam trays can be obtained from the meat department of a grocery store.
-

Activity

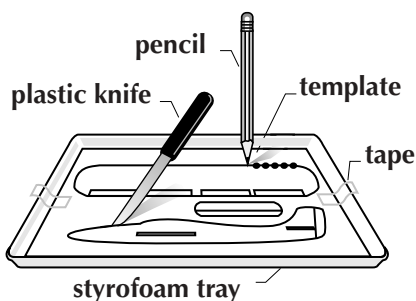
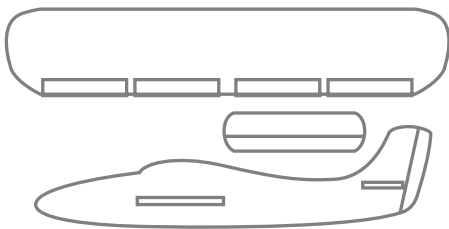

1. Hand out the materials (Student Page 1, tray, template, cutting and marking devices). Follow the steps listed on the Student Page.
2. Explain that the template is a guide to cut the wings, fuselage, and elevator from the Styrofoam. Cutting can be done in a variety of ways depending on grade level.

For younger students, the teacher or older students can cut out the parts beforehand and have the students assemble the glider. For older students, the teacher can demonstrate cutting out the parts using a serrated plastic knife.

Another way to cut out the parts is by punching a series of holes approximately 2 mm apart around the outside edge of each piece and then pushing the piece out. A sharp pencil or round toothpicks can be used to punch the holes.



3. Use sandpaper or an emery board to sand the edges smooth.
4. Have students assemble the glider by inserting the wings and elevator into the fuselage slots.

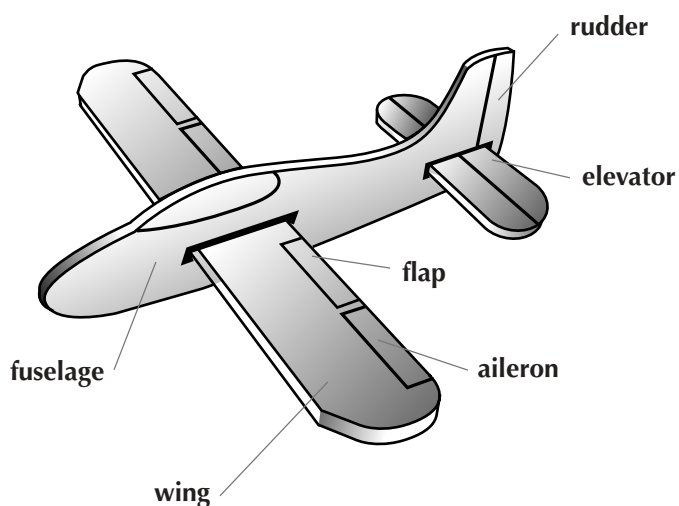
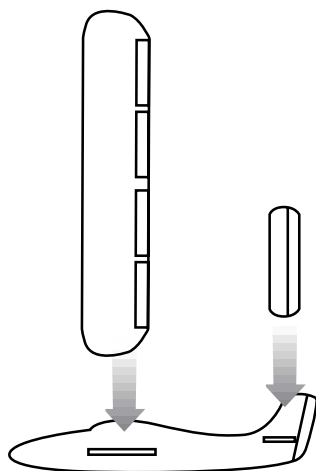

Extension

1. Students may apply personal and finishing touches to the model by drawing the canopy outline and adding color, name, aircraft number, squadron logo, icons, or emblems.
2. Ask students to label the parts of an airplane on the model glider.
3. Civilian aircraft have a letter or letters preceding the aircraft's identification number indicating in which country the aircraft is registered. Mexico uses the letter "X," Canada uses the letters "CF." Aircraft registered with the Federal Aviation Administration in the United States are assigned identification numbers that begin with the letter "N." The airplane's identification number is called an N-number. Students may apply N-numbers to their model, or "register" their model with other countries.

Part 2

Caution students not to throw gliders toward other students. The teacher may want to provide eye protection for each student.

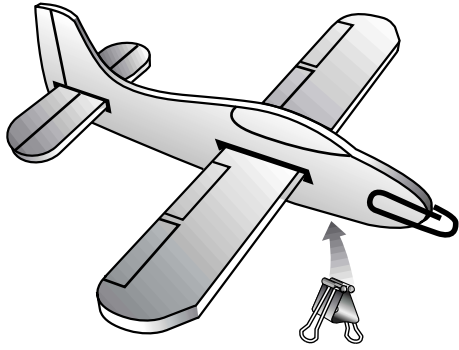

1. The model glider's weight must be balanced or distributed properly before it will fly. To demonstrate this, ask a student to launch a glider before adding weight and balance. Have students describe the flight characteristics.
2. Add weight to the model using paper clips, binder clips, or a penny. Attach the paper clip or penny to the nose of the glider. If a binder clip is used, attach it to the bottom of the fuselage. Ask the students to test fly the glider and observe the flight characteristics.
3. Move the weight (clips) forward or backward on the fuselage to determine the best weight and balance for the glider. The best weight and balance combination can be defined as one that allows the glider to fly the greatest distance.

Discussion

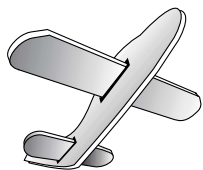
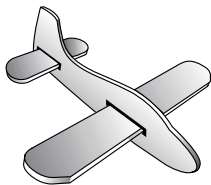

1. Is weight and balance important on "real" airplanes? *Yes, all airplanes are required to have correct weight and balance. The pilot is responsible for making sure the total weight of the cargo and passengers is within certain limits and is distributed to keep the plane properly balanced. Flights should not be attempted if the aircraft is overloaded, or if the cargo distribution makes the plane too "nose heavy" or "tail heavy."*
2. Why does the model glider fall erratically during test flights before its proper weight and balance is determined? *Lift is a force generated by the wing. This force must be in balance with the weight distribution of the airplane before the model will fly successfully.*

Aircraft weight is balanced as a pencil is on your finger.



Assessment

1. Students will successfully meet one objective of the activity by constructing the model glider.
2. Using the model glider, have students explain how they determined the weight and balance for their glider.

Extensions

1. Set up a flight course and have the students demonstrate the flight characteristics of their gliders.
2. Have students cut 2 cm off of each wing tip, and begin a new series of flight tests.
3. Have students design and make new wings for the glider. Experiment with wings of various sizes and shapes.





Right Flight

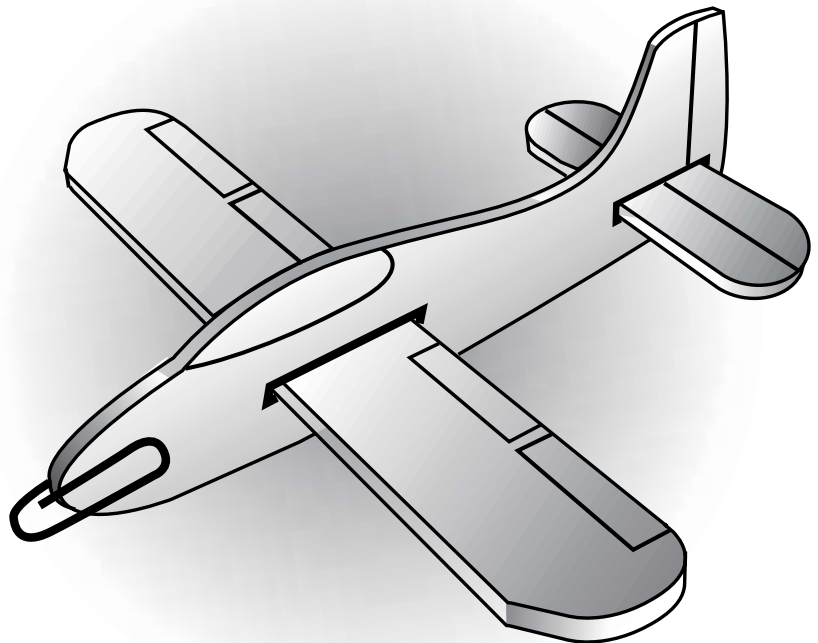
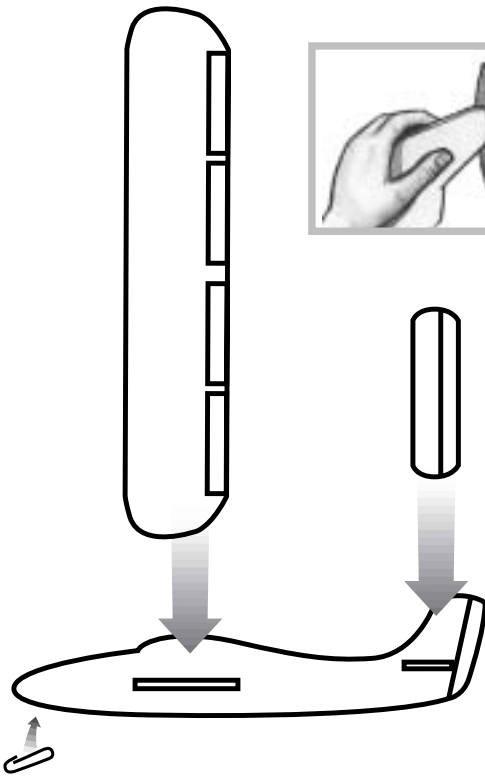
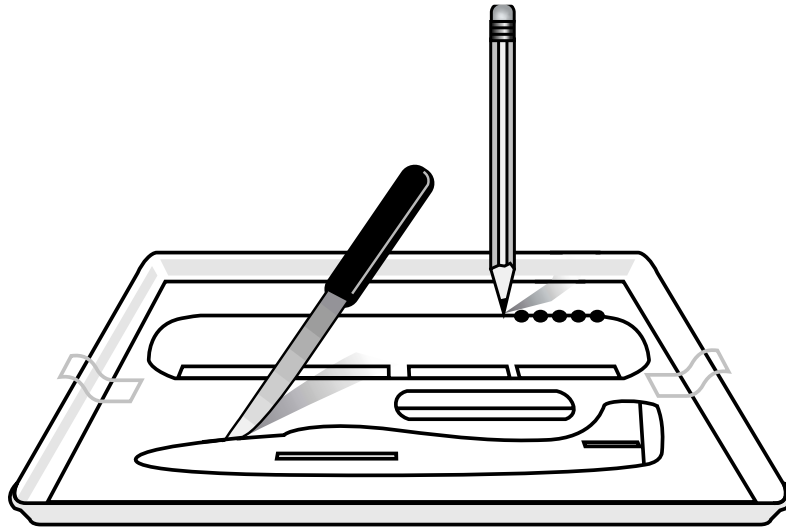
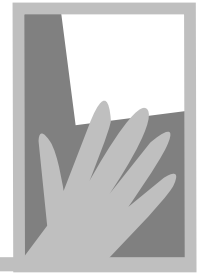

Glider Template

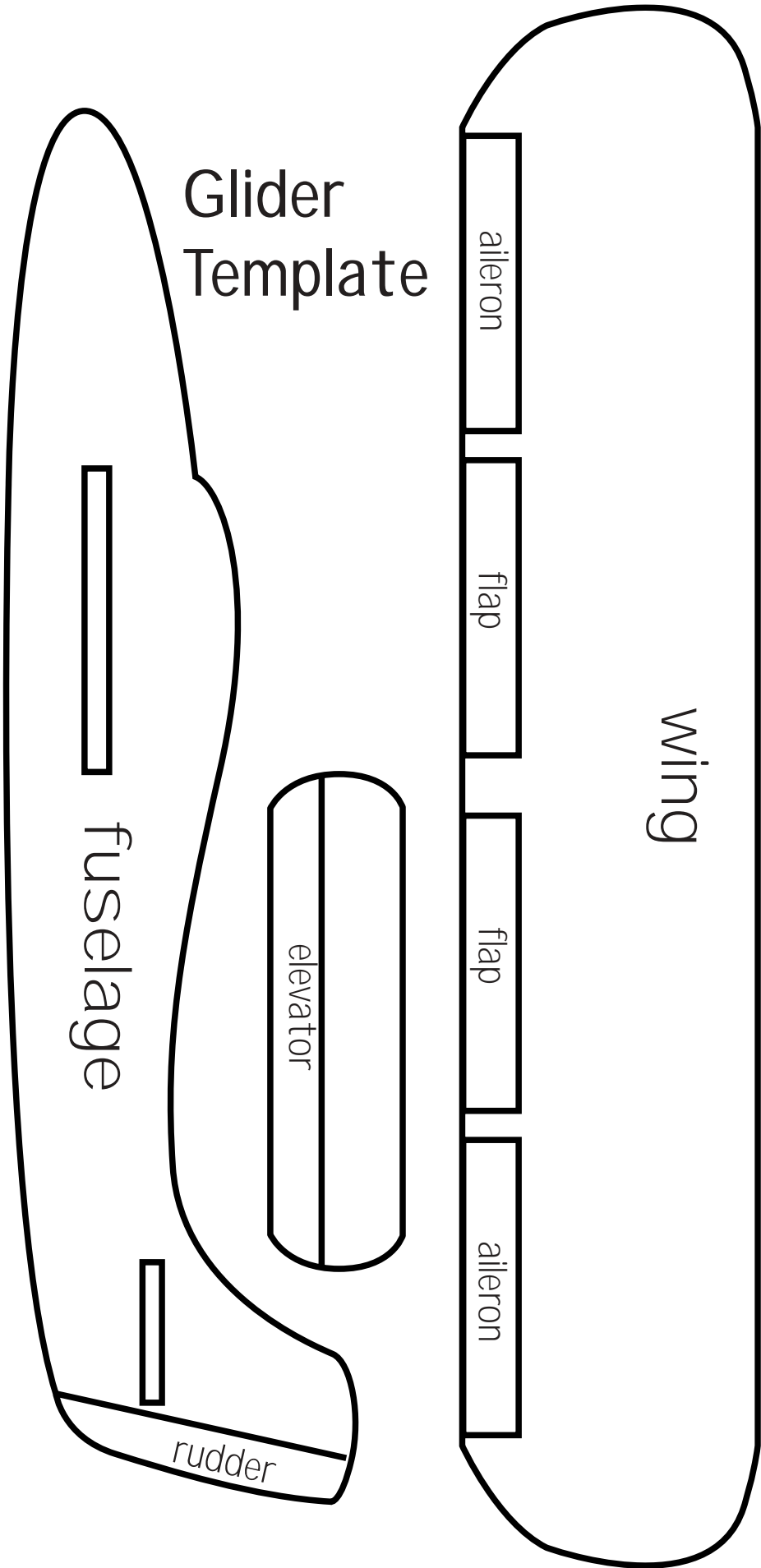

DELTA WING GLIDER

Objective

The students will:
Learn how to change the flight characteristics of a glider.
Conduct an experiment to answer a question.

Standards and Skills

Science

Science as Inquiry
Physical Science
Science and Technology

Mathematics

Measurement
Problem Solving

Science Process Skills

Making Models
Investigating
Predicting

Background

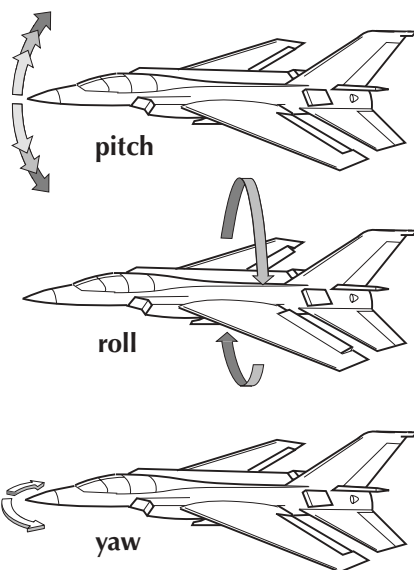

There are many types of vehicles used to transport people and objects from place to place on Earth. How are these vehicles guided to a destination? Turning the steering wheel changes a car's direction. The rudder is used to control the direction of a boat. A bicycle is controlled by turning the handle bars and shifting the rider's weight. For most land and sea vehicles, directional control is accomplished by moving the front end right or left. Movement in this one axis of rotation or direction is called yaw.

Flying an airplane requires control of three axes of rotation or movement. The nose of the plane can be moved right and left (*yaw*), rotated up and down (*pitch*) and the fuselage can be rolled left and right (*roll*). A pilot uses the control wheel or stick inside the airplane to move control surfaces on the wings and tail of the plane. These control surfaces turn the airplane by varying the



forces of lift.

Airplanes with conventional wings use *ailerons* to control roll, a *rudder* to control yaw, and *elevators* to control pitch. Airplanes with delta or triangular shape wings have a rudder, but only one control surface (*elevon*) to control pitch and roll. An elevon serves the same function as an *elevator* and an *aileron*.

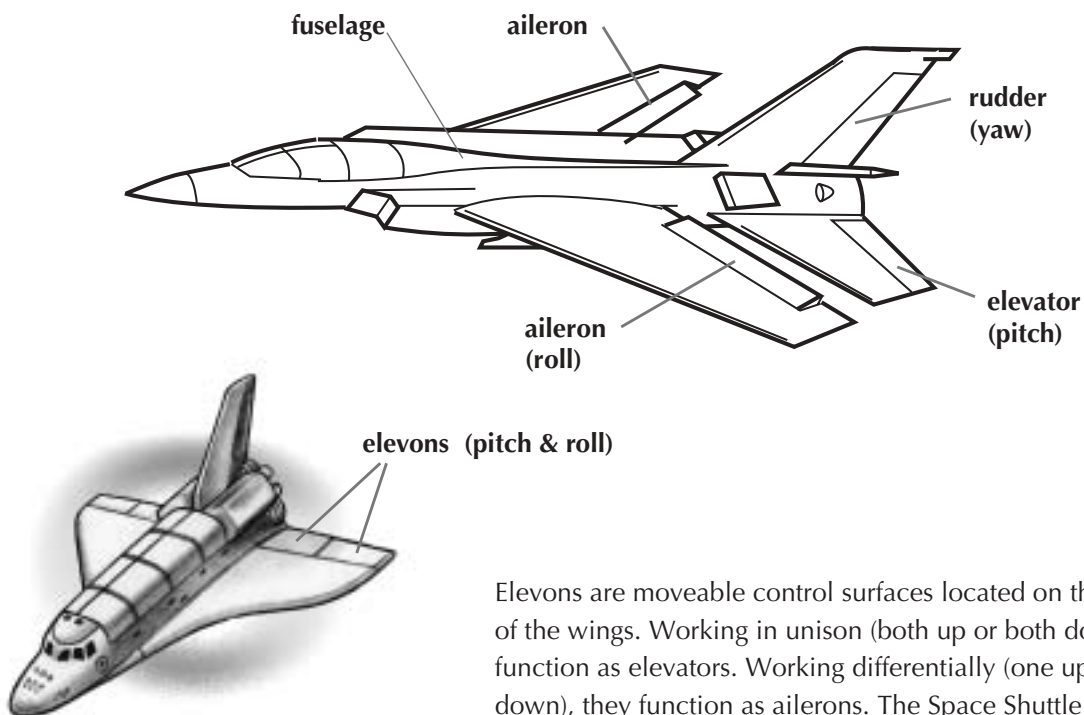

Elevons are moveable control surfaces located on the trailing edge of the wings. Working in unison (both up or both down) they function as elevators. Working differentially (one up and one down), they function as ailerons. The Space Shuttle uses elevons for control in the air close to the Earth as it descends from space.

Materials

Styrofoam food tray, about 28 cm X 23 cm (Size 12)
Cellophane tape
Paper clip
Ball point pen
Plastic knife or scissors
Toothpicks
Goggles (eye protection)
Emery boards or sandpaper

Preparation

1. Show the class a Styrofoam food tray and ask them to identify it. Ask the students to list other uses for Styrofoam. Responses may include cups, fast food containers, egg cartons, packaging material, and insulation.
2. Discuss with the students some reasons for using Styrofoam in the construction of a model glider. Materials for building airplanes must be lightweight, strong, and readily available. These qualities make Styrofoam a good material for the

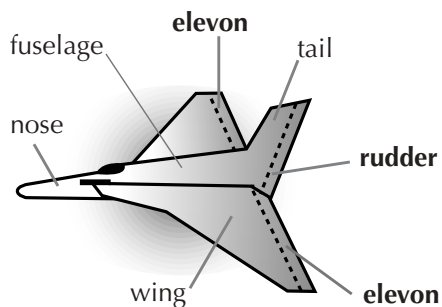

construction of flying models. Real airplanes are made from another lightweight, strong, and readily available material called aluminum.

3. Styrofoam can be cut using scissors or a serrated plastic knife. Students can also use a sharp pencil or round toothpick to punch a series of holes approximately 2 mm apart around the outside edge of the part. The part can then be pushed out from the tray. Pre-cut the Styrofoam parts for younger students.
4. Provide the student with a word list for parts of the glider. *Fuselage (body of the glider), wing (provides lift), rudder (yaw control), elevons (roll and pitch control).*

Activity

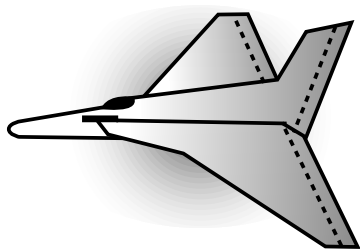
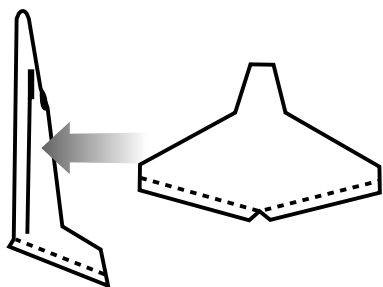
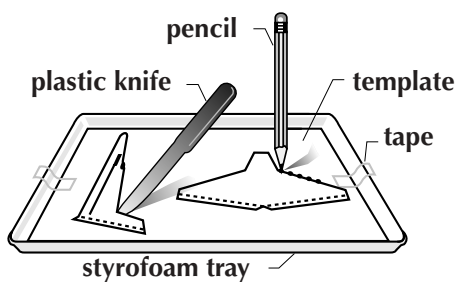

1. A student page contains a template used to cut out the Styrofoam parts of the glider, and instructions for assembling the parts. Educators of K-2 students may want to cut out the gliders ahead of time.
2. Ask the student to write the name of each airplane part on the template.
3. Tape the glider template to the Styrofoam meat tray.
4. Use a sharpened pencil or toothpick to punch holes around the outline of the wing and fuselage. Make sure the hole goes through the Styrofoam.
5. Remove the template and trace around the outline of the wing and fuselage on the tray using a pencil or toothpick. Punch out each part.
6. Smooth the edges of each part using sandpaper or an emery board.
7. Mark both elevon hinges with a pencil. (Note: to make the elevons hinge up and down, use a pen to lightly score the hinge line on the Styrofoam wing. If a break occurs at the hinge line, use clear tape to repair the break.)
8. Carefully cut a slot in the fuselage and slide the wing into it.



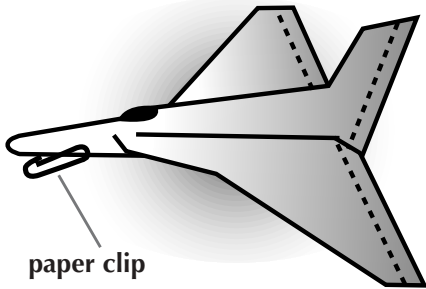

9. After constructing the glider, the students determine the "weight and balance" by attaching a paper clip or binder clip to the fuselage. Students should vary the position of the clip with each flight until the glider flies the greatest distance in a straight line.
10. The flight test questions found on the Student Page can be answered by conducting flight experiments. The students change the position of the elevons and draw a diagram to record the flight path of the glider. Test fly the glider and record the results.

Discussion

1. Do all gliders fly alike? *No. Small differences in construction can change the flight characteristics of a model glider.*
2. Why do we predict what will happen before a test? *Predictions help scientists decide what questions the experiment will answer.*

Extensions

1. Have students measure and record the distance of the longest flight.
2. Have the students change the size or shape of the wing. Test fly the redesigned glider and record any changes in the flight characteristics.

Assessment

1. Bend the control surfaces on a model glider and ask the students to predict what flight path it will follow. Students can walk the predicted flight path, and launch a glider to test the prediction.
2. Group students together and have them submit a Team Student Record Sheet that summarizes the experimental flight test results.



Delta Wing Glider

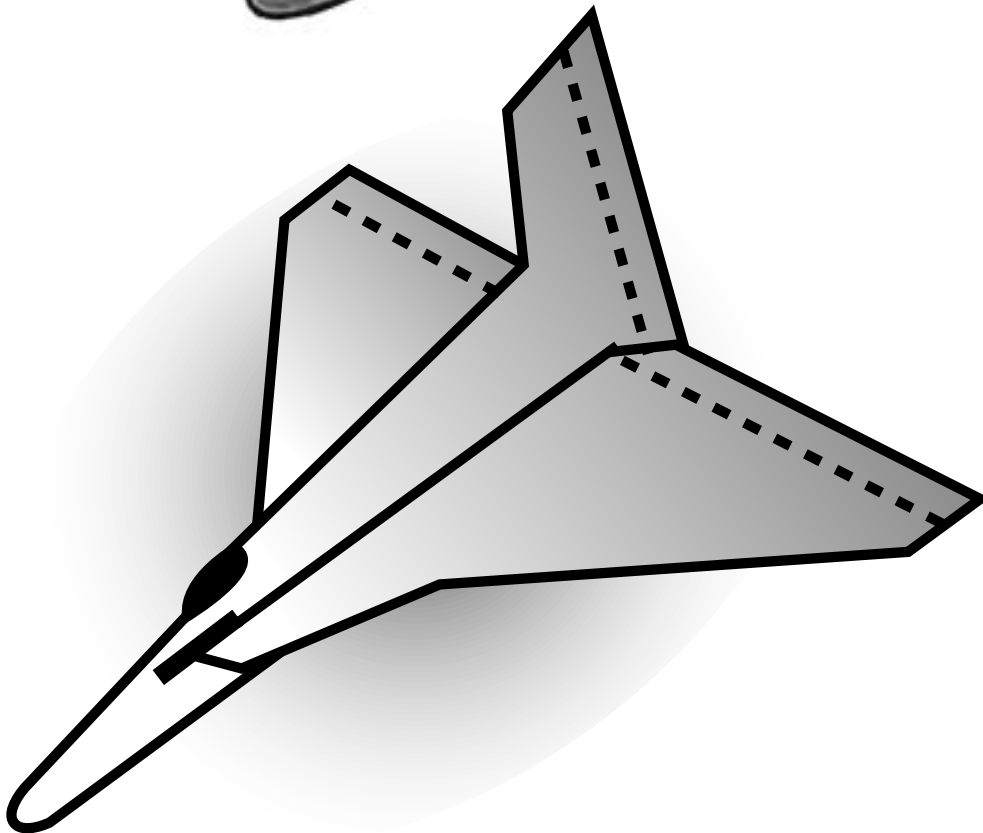
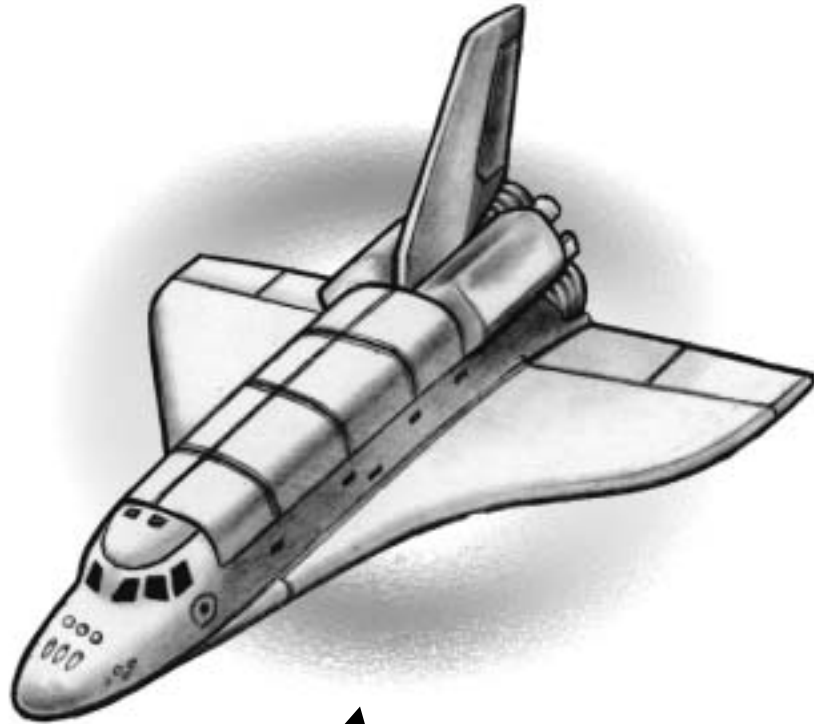
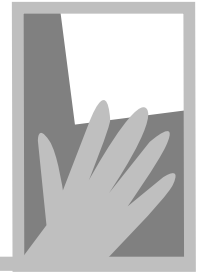



Delta Wing Glider

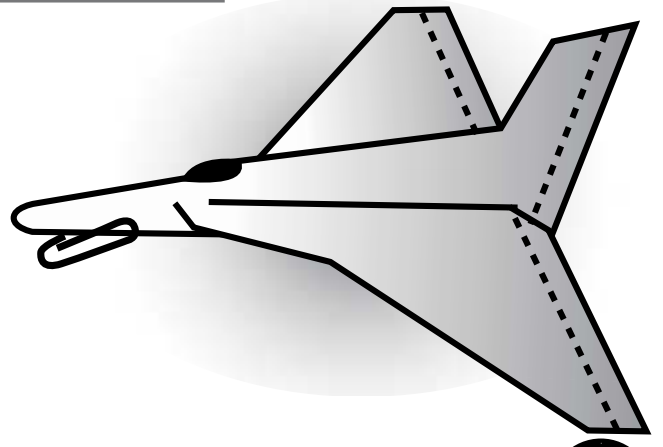
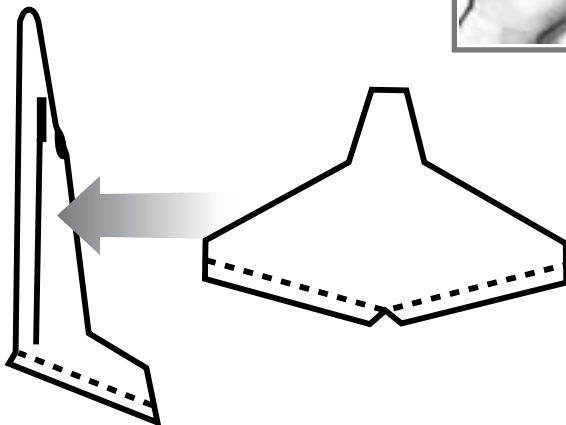
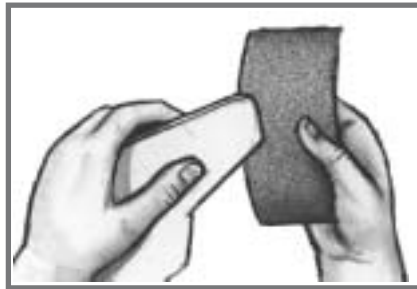
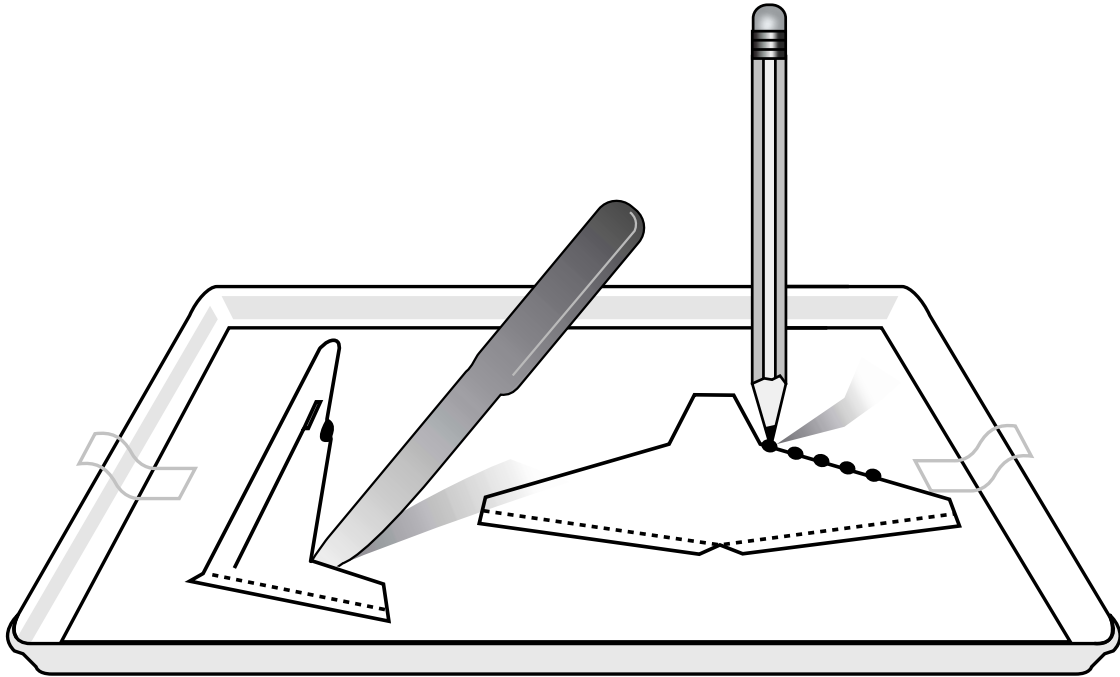
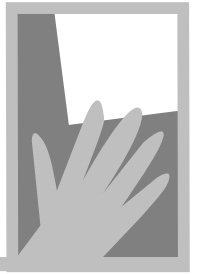

Glider Template

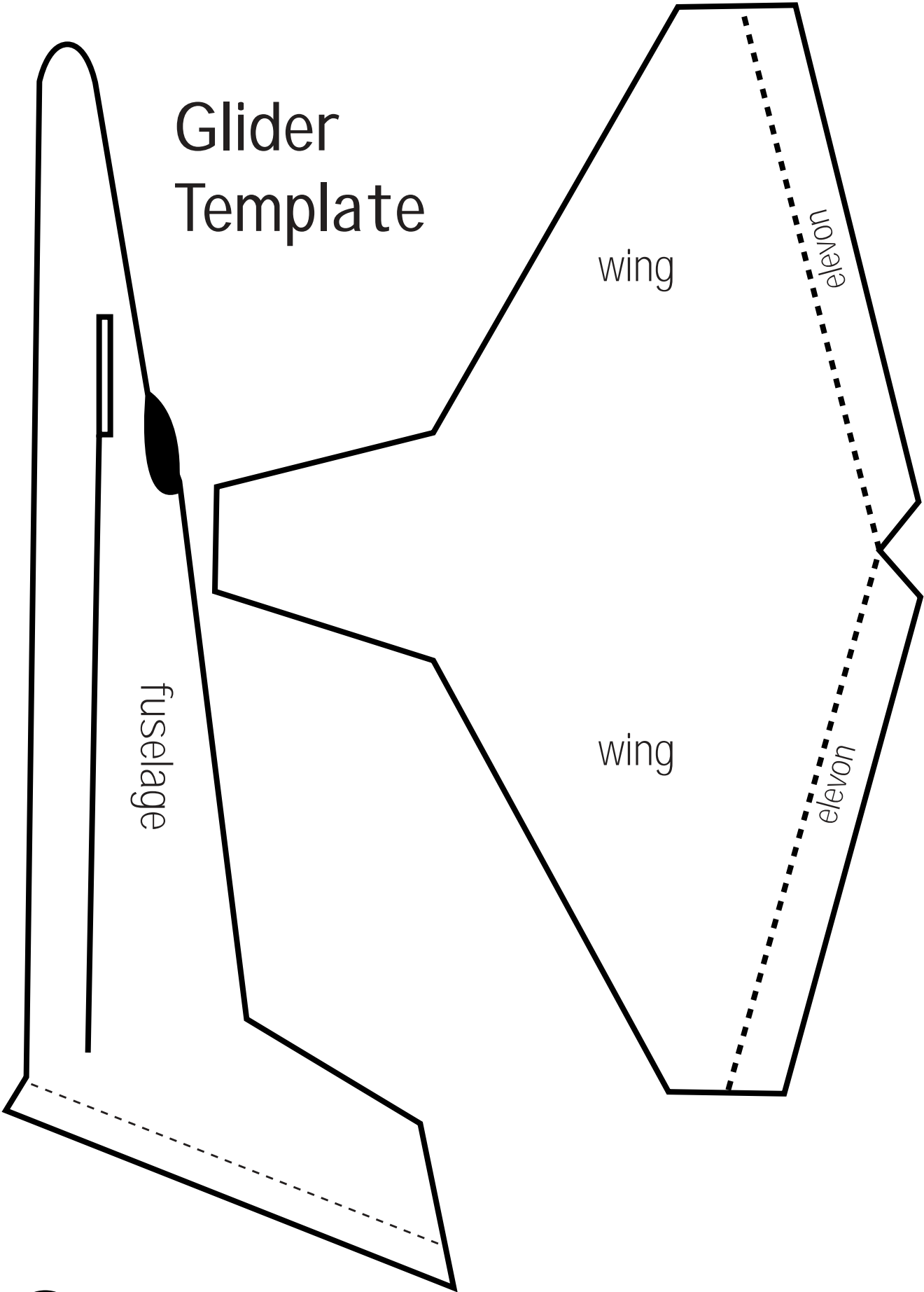



Delta Wing Glider

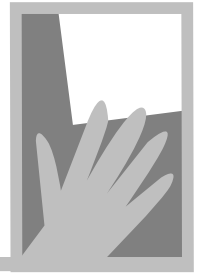

Test Question: Does changing the position of the elevons on a delta wing glider change its flight path?

Directions: Bend the elevons into the positions listed below. Be sure to predict the flight path before flying the glider. Test fly the glider and record the results (up, down, left, right).

Student Test Pilot Record Sheet (What I Observed)

Position of elevons		Predicted Flight Path	Path of Test Flight
Right and left straight		-----	-----
Right and left up		-----	-----
Right and left down		-----	-----
Right down, left up		-----	-----
Right up, left down		-----	-----

Does moving the elevons change the way the glider flies?

What happens when both elevons are in the up position?

What happens when both elevons are in the down position?

Does changing the position of elevons on a delta wing glider change its flight path?





Delta Wing Glider

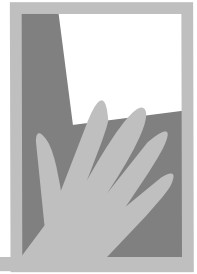

Draw the flight path

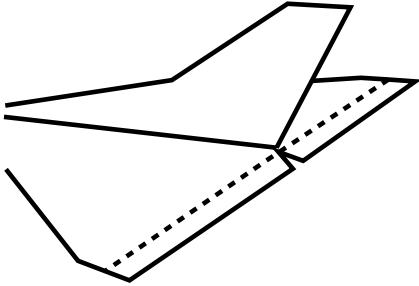

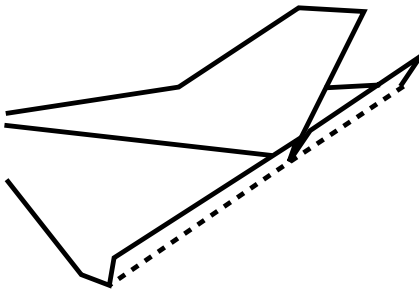

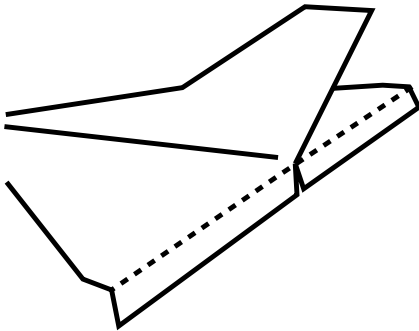

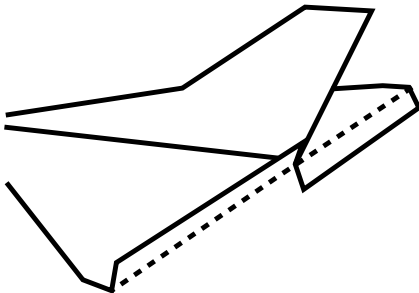

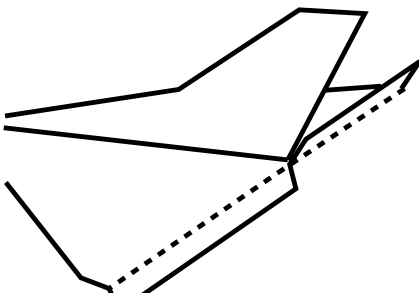



ROTOR MOTOR

Objectives

The students will:
Construct a rotary wing model.
Define a mathematical relationship using a model.

Standards and Skills

Science

Science as Inquiry
Physical Science
Position and Motion of Objects
Science and Technology

Science Process Skills

Observing
Making Models
Controlling Variables

Mathematics

Problem Solving
Estimation
Measurement
Graphing

Background

Air must move across the surface of a wing to produce lift. To fly, birds and insects use a flapping motion to move the air over and around the wing surface. The wings of airplanes are attached to the fuselage in a fixed position. Lift is generated by moving the entire wing and body through the air. *Helicopters* are *rotary wing aircraft*; they rotate the wing surface through the air to produce lift.



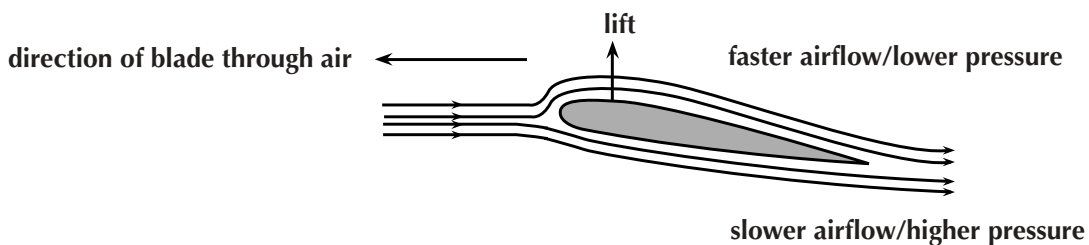
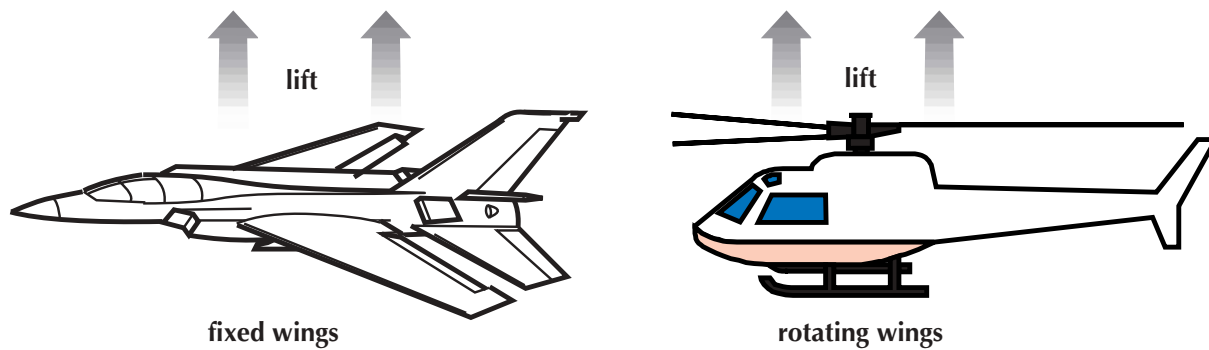

cross section of aircraft wing, or a rotor blade

Lift is produced by the pressure differences caused by the shape of rotating blades; this is the same way lift is produced by aircraft wings. The rapidly moving air over the top of the blade creates low pressure; the air beneath the blade is moving slower, so it creates higher pressure (see "Paper Bag Mask" pages 26-27, Bernoulli's principle, for more information). High pressure under the rotor blades creates lift which causes the aircraft to rise.

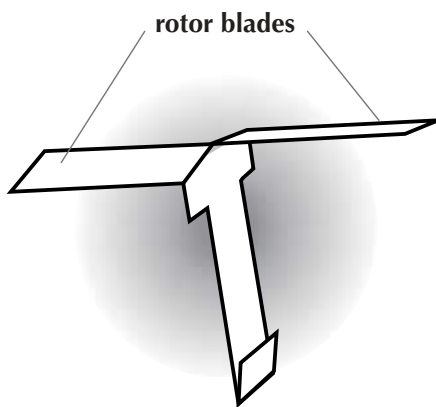

paper model

Since the paper models have no motor, they only have one source of lift. As the paper models fall they will spin, imitating the rotation of the rotor blades of a helicopter. Because there is no thrust to produce upward movement, the helicopter will not fly upward, but the spin will reduce the rate of fall by producing lift, resisting the force of gravity.

NASA builds and tests experimental helicopters and *tiltrotor* airplanes in an effort to achieve lower noise levels and greater fuel efficiency. Models are tested in NASA's wind tunnels at Langley, Lewis, and Ames Research Centers.

Materials

Plain white paper
Graph paper
Student Page with template and graph
Scissors
Measuring tape
Pencil or marker
3 m length of lightweight paper ribbon (or a strip of audiotape or videotape)

Management

The activity will take approximately 30-45 minutes.

Preparation

Open an old audio or videotape cassette and show the class the tape inside the cassette. The tape will be used for the activity.

Team students with a partner or in cooperative groups of three or four.

Make enough copies of the rotor motor template so each team may construct a rotor motor. Have students use the template to construct rotor motors.

Activity

1. Cut along the solid lines of the template.

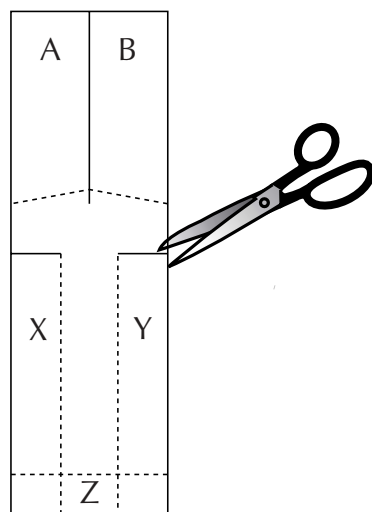

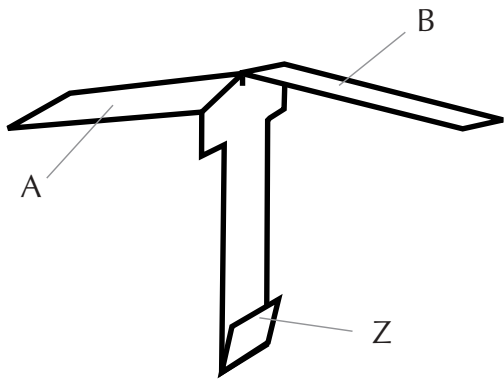

2. Fold along the dotted lines. The propeller blades should be folded in opposite directions. X and Y fold toward the center, and Z is folded up to give the body rigidity, and lower the center of gravity.
3. Stand up and drop the rotor motor. Have the students write or draw what they observed.
4. Drop an unfolded piece of paper and the rotor motor. Which one falls faster? *The paper falls faster because it is not continuously generating lift. The spinning rotor motor reduces the rate of fall by producing lift, resisting the force of gravity.*
5. Have the students predict what will happen when they wad up the paper and drop it. *It will drop faster than the sheet of paper and the rotor motor. The sheet of paper falls slower mainly because its larger surface area offers more resistance to the air than the compact, wadded paper.*

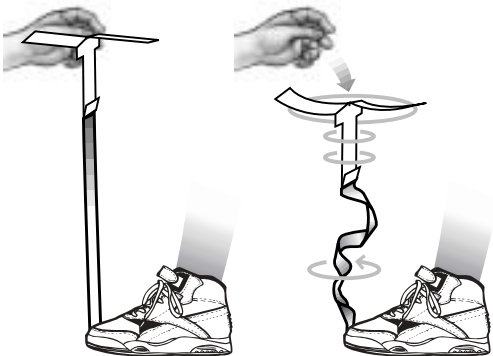
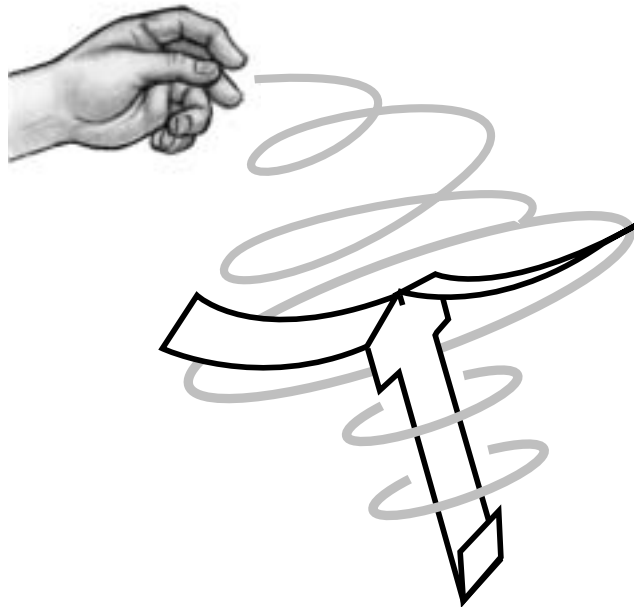

6. Can you accurately count the number of rotations the rotor motor made as it descended? *No—the rotations are fast and that makes accurate counting very hard.*
7. To determine the number of rotations, (1) tape the cassette ribbon to the rotor motor, (2) stand on the loose end, and pull the rotor up so there are no twists in the ribbon, and (3) drop the rotor as usual. How does the cassette ribbon make counting the rotation easier? *Each twist in the ribbon represents one rotation of the rotor motor. Counting the total number of twists equals the total number of rotations.*

Assessment

1. The teacher can observe the construction activities in progress.
2. Formulate a rule describing the relationship between the number of twists and the drop height of the rotor motor.

Extensions

1. Have students experiment with helicopters made from different weights of paper. Graph the results.
2. Have students design a new rotor motor.
3. Have students determine relationships between the weight, height of launch, shape, and length of the blades.
4. Have students determine whether the blades turn in a clockwise or counterclockwise direction.
5. Have students increase and decrease the angle of incidence (see illustration) of the rotor blades, and determine if the new angles make the rotor motor rotate faster or slower, and if it flies longer.
6. Have students compare the flight of the rotor motors to that of a maple seed or a dandelion.
7. Seasonal variation: design paper helicopters shaped like bunnies, ghosts, or reindeer.
8. Construct a bar or line graph that shows the relationship between the number of twists and the drop height of the rotor motor.

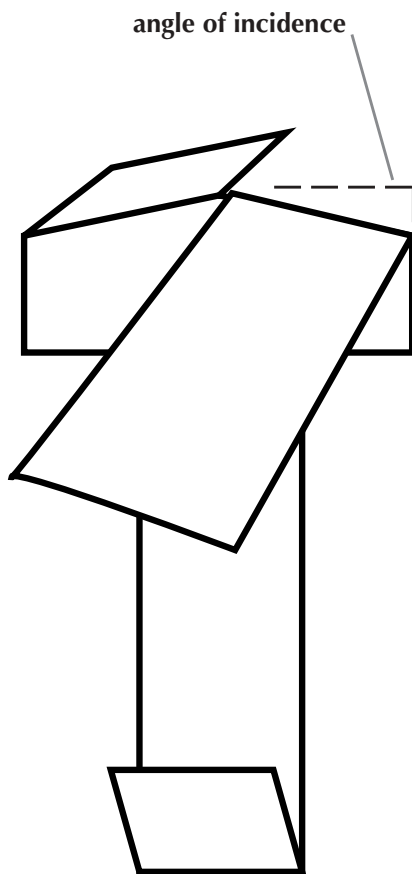

Rotor Motor Templates

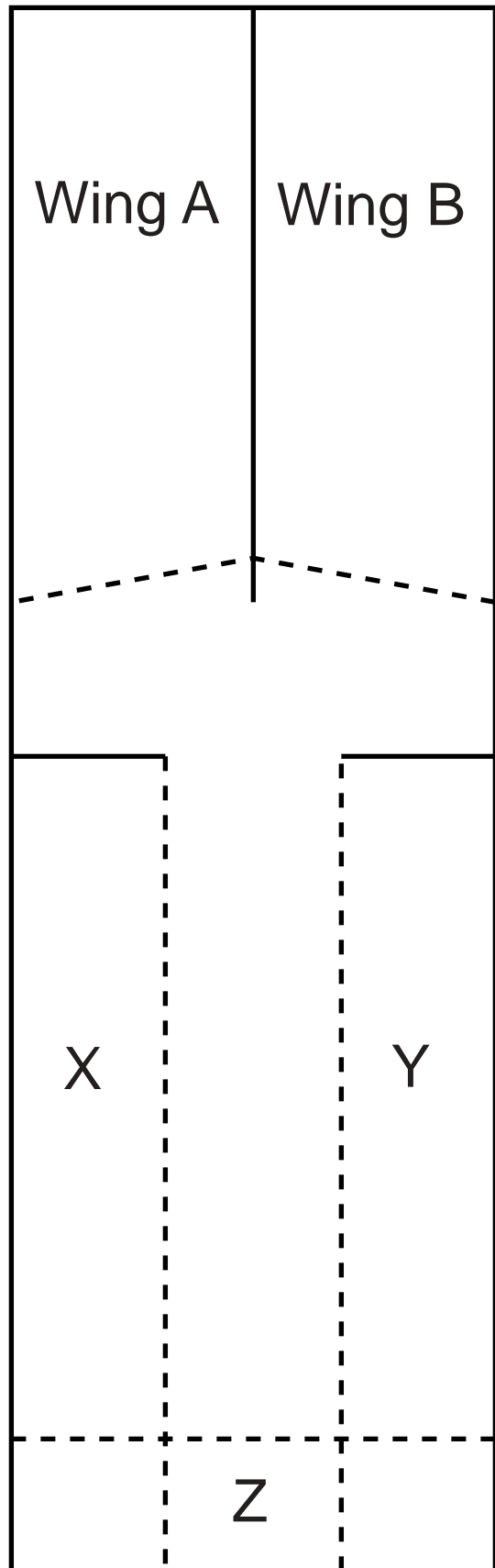
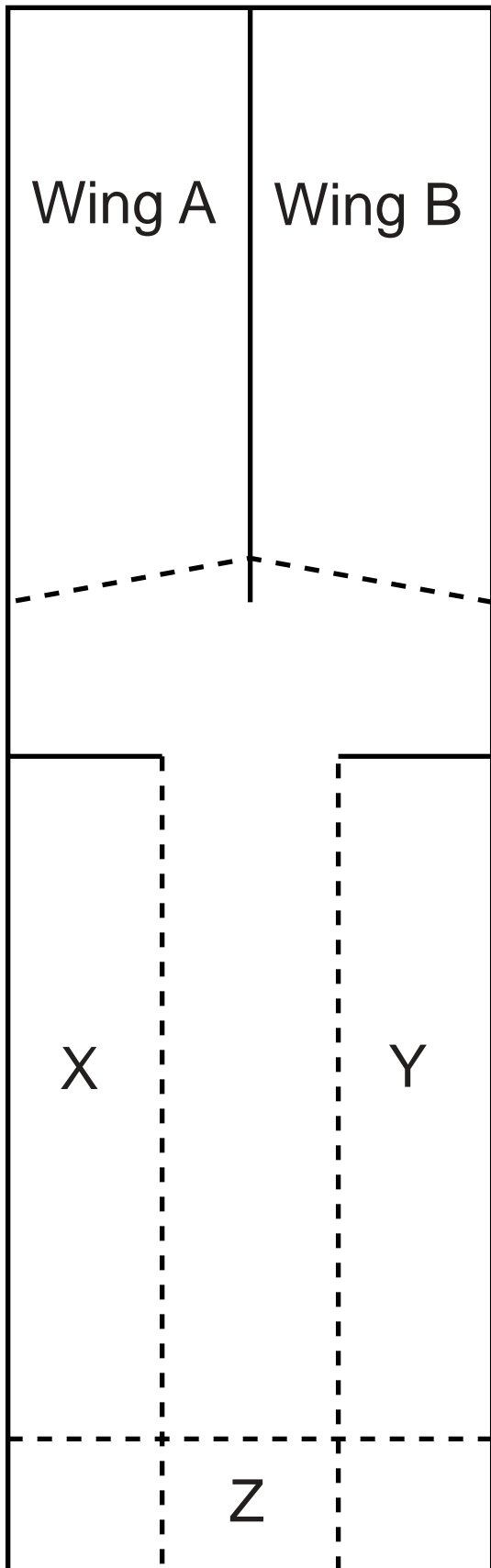



Rotor Motor

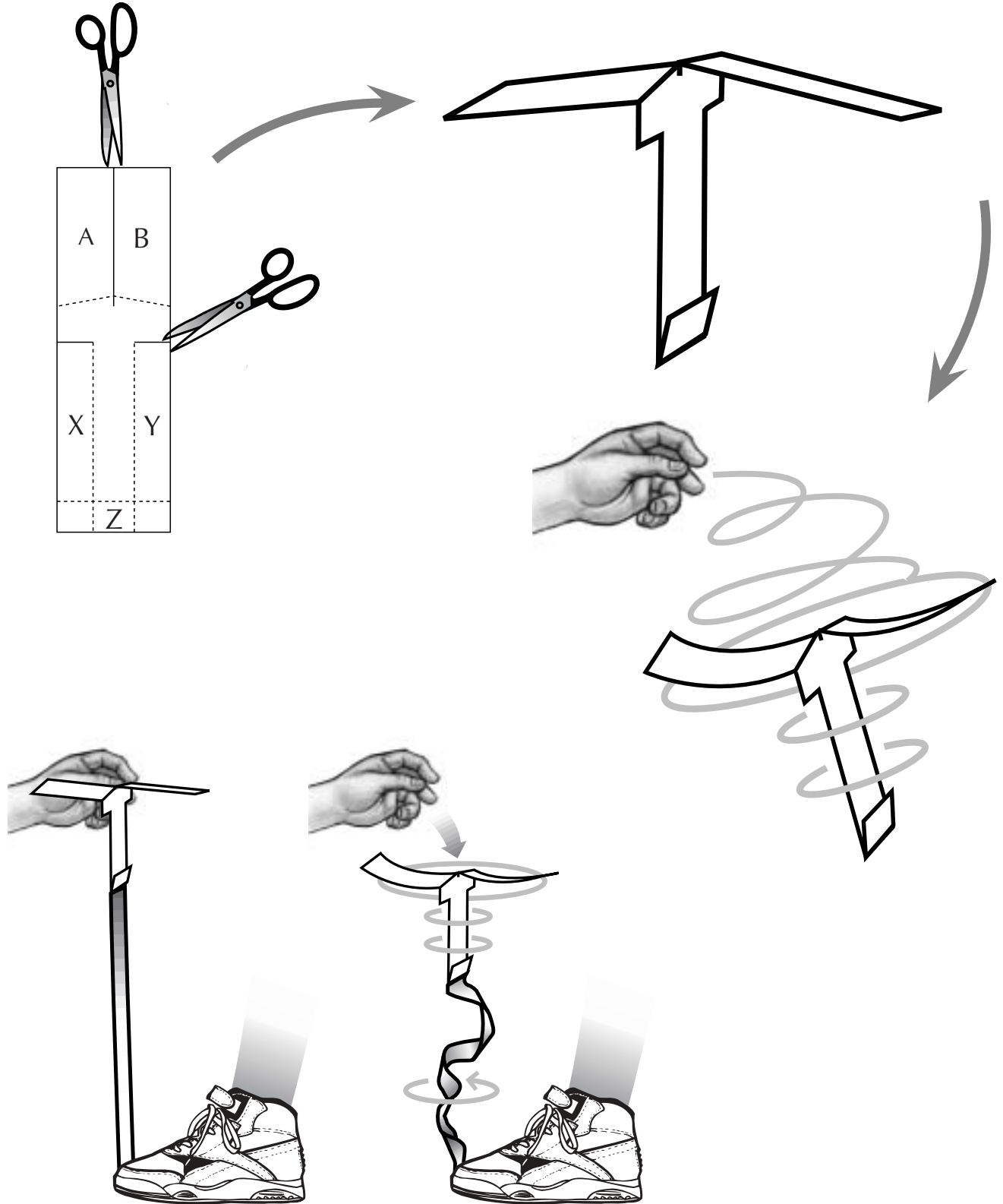
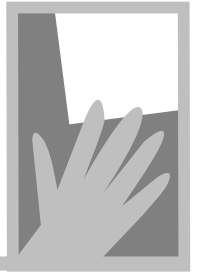

FLIGHT

INTERDISCIPLINARY LEARNING ACTIVITIES

Science

- Compare bats with airplanes.
- Discuss why some birds fly and some do not.
- Predict how aircraft will function in space (see NASA's *Lift-off to Learning: Toys in Space II* video).
- Discuss why some plants have seeds that “fly.”
- Discuss why wind is important to flying.
- Compose a list of living things that fly and a list of those that do not fly.
- List safety concerns pilots address when flying in aircraft.
- Compare and contrast how helicopters and airplanes fly.
- Compare and contrast some of the different kinds of aircraft.

Mathematics

- Experiment building kites with different geometric shapes. Determine which kite flies the best.
- Determine how fast students can flap their arms. Graph and compare.
- Many birds migrate. Using a map, calculate how far some birds travel when they migrate.
- Make an aircraft drawing by connecting dots using numbers that require students to count by 2s or 3s.
- Test fly a paper or Styrofoam glider and determine the glide time. Record and graph results.



Fine Arts

- Design an airplane stamp.
- Outline the shape of an airplane using a meter-length piece of string or yarn.
- Create a song about flying.
- List popular songs that contain flying as a theme.
- Build kites shaped like musical instruments.
- Draw pictures of things flying through the air.

Technology Education

- Design and construct different types of kites. Experiment with the designs to determine which kites fly the best.
- Design and build different types of gliders or paper airplanes.
- Construct models of different aircraft using popsicle sticks.
- Make an airplane using common household items.
- Design a unique aircraft on a computer.

Social Studies

- Create a pictorial history of flying, including kites, balloons, helicopters, and airplanes.
- Discuss the impact flying machines have had on civilization.
- List the many jobs and careers that were created by the industry of flight.



Language Arts

- Create an ABC picture dictionary of flight.
- Read mythology stories such as Icarus that are related to flight.
- Locate stories about flying in the school library.
- Have students write poems about flying.
- Maintain a “Book Center” with flight-related stories for students to read.
- Write open-ended stories about flying and have the students complete them.
- Develop flash cards for the parts of an airplane.
- Have students spell their names using the International Phonetic Code Alphabet.
- Make a bulletin board using aviation words that begin with the letters of the alphabet.
- Have students who have flown write about their experiences.



We Can Fly, You and I

<i>Making Time Fly</i>	80
<i>Where is North? The Compass Can Tell Us</i>	87
<i>Let's Build a Table Top Airport</i>	91
<i>Plan to Fly There</i>	97
<i>Interdisciplinary Learning Activities</i>	107



MAKING TIME FLY

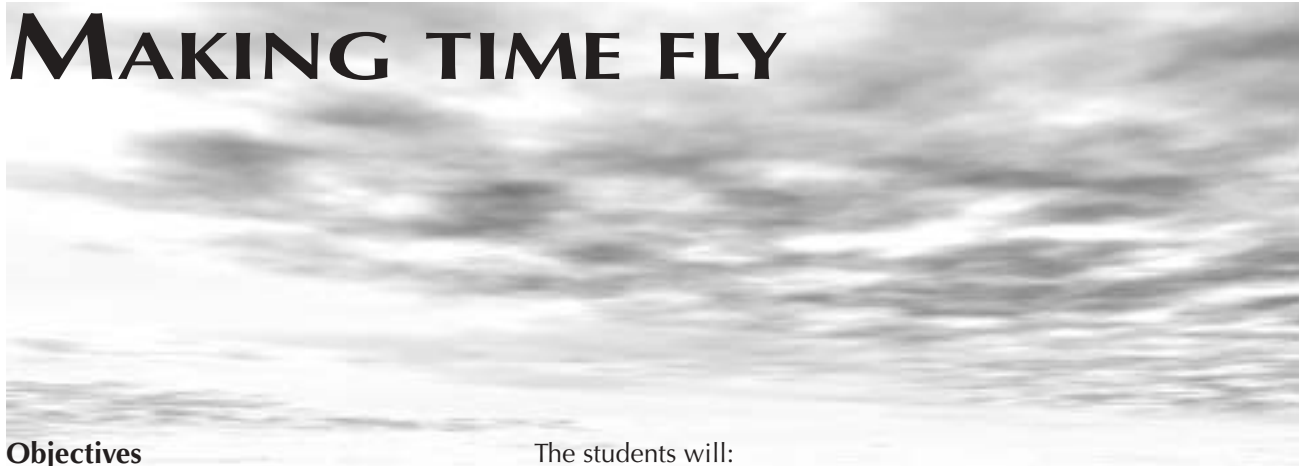

Objectives

The students will:

- Identify and research aviation events.
- Create a time line of aviation events.
- Analyze the information to interpret changes in aviation.
- Develop a presentation based on historical events in aviation.

Standards and Skills

Science

Science in Personal and Social Perspectives
History and Nature of Science

Science Process Skills

Communicating
Investigating
Collecting Data

Mathematics

Problem Solving
Communication

Background

Each event in a time line can be thought of as a link to the past or future of something. Building an aviation time line based on drawings or models helps students visualize the numerous changes that have occurred in the history of aviation.

The changes in aviation offer important clues to help students not only understand the concept of advancement and improvement, but also the reasons behind the changes.

In 1783 the balloon became the first human-made device capable of lifting humans into the air. It allowed humans to fly, but balloons drift with the wind, and the speed and destination of each flight depended largely upon the weather. The limitations of ballooning inspired people to develop new technologies to expand the realm of flight. Change was inevitable. Propulsion was added



to the balloon to help control its flight path, increase its speed, and make it move against the wind.

When powered, controlled flight became possible with the Wright Flyer airplane in 1903, changes in aviation happened at a quick rate. Many of the changes were driven by aviators' desire to fly higher, faster, and farther. Some changes occurred to satisfy specific, practical requirements: the flying boat permitted flight operations from bodies of water, and the helicopter could takeoff and land practically anywhere. Navigation instrumentation allowed for flights in adverse weather and darkness.

Other changes occurred to satisfy the human spirit. Advanced gliders allowed people to soar with the birds, and acrobatic airplanes allowed pilots to dance in the sky.

Creating a time line requires students to find out all they can about an event. Research information for a time line can be obtained from many sources. Books, magazines, newspapers, and people are a few examples. A vast amount of information is also available on the Internet.

More information about some of the events listed in this activity are contained in the "Aeronautics Background for Educators" section of this guide (pp. 10-12).

Management

The amount of time required for this lesson will be primarily determined by how much time the students are assigned for research. Students may work individually, in pairs, or small groups.

Activity

1. Show students a picture of a modern airliner that can be found in a magazine or book. Ask them if this is the type of plane in which people have always flown.
2. Review what a time line is and why it is an important way of displaying information.
3. Hand out the Student Pages (Time Line Events, and illustrated Time Line). Briefly discuss events on the sheet and how they depict a time line.



-
4. Explain to the students that they are going to research aviation events and create a time line that shows important people and changes in aviation. Each student or pair of students should find out all they can about an event and be able to draw a picture of it.
 5. Once students have completed their research, they can decide how the event will be displayed in the time line. Students can design cards for the time line or build a paper model. Other ways to display the event include magazine cutouts, pictures, and models made from recycled or "throw away" items found around their home.
 6. Bring all items together to form a class time line. The time line can be hung from the ceiling, attached to a wall or put on a shelf or table. Ask each student to present and position his or her event on the time line.

Discussion

1. How important was the event you researched to changes in aviation?
2. If a particular time line event had never occurred, how do you think this might have changed aviation history?
3. How did the time line that the class created help you to learn about aviation history?

Assessment

Students will successfully meet the objectives of this lesson by researching an aviation event and creating their part of the time line.

Extensions

1. Have students predict what future events and designs in aviation might look like. Draw pictures and write about it.
2. Using the information gathered in the students' research, have them write a report or story about their event.
3. Have students pretend they are one of the aviation characters that they researched. Groups of students can role-play the characters in skits or plays.





Time Line Events

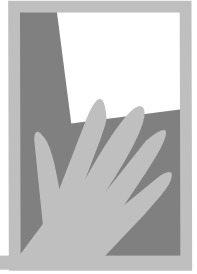

Use these events to begin your time line

Key words are in the events below.

- 400 B.C. The first *kites* were invented by the Chinese.
- 1485 *Leonardo da Vinci* designed the *ornithopter* (a wing flapping aircraft).
- 1783 *Joseph and Etienne Montgolfier* launched the first passengers—a duck, a sheep, and a rooster—in a *hot air balloon*.
- 1849 *Sir George Cayley*, “The Father of Aerial Navigation,” designed the first three-wing *glider* that lifted a person off the ground.
- 1891 *Otto Lilienthal* built the first practical *glider* for long flights.
- 1903 The *Wright Brothers* developed the first motor-powered *airplane* that a pilot could control.
- 1907 *Paul Cornu* built the first free flying *helicopter*.
- 1919 *Lieutenant-Commander A.C. Reed* and his crew were the first to fly across the Atlantic Ocean, making several stops, in the *Curtiss Flying Boat*.
- 1927 *Charles Lindbergh* was the first person to fly across the Atlantic Ocean nonstop.
- 1935 *Amelia Earhart* was the first person to fly solo across the Pacific Ocean from Hawaii to California.
- 1947 *Chuck Yeager* became the first pilot to break the sound barrier.
- 1979 The *Gossamer Albatross* was the first craft powered by a human (Bryan Allen) to fly across the English Channel.
- 1986 Dick Rutan and Jeana Yeager flew *Voyager* around the world nonstop without refueling.
- 1997 The NASA/AeroVironment *Pathfinder* became the first *solar-powered aircraft* to fly above the troposphere.





Time Line

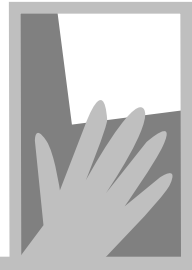

400-350 BC

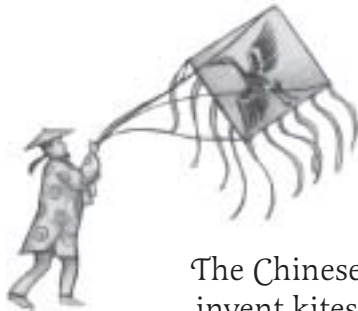

The Chinese
invent kites
400 BC

1450-1499



da Vinci ornithopter
1485

1750-1799



First hot air balloon
Montgolfier brothers
1783

1800-1850

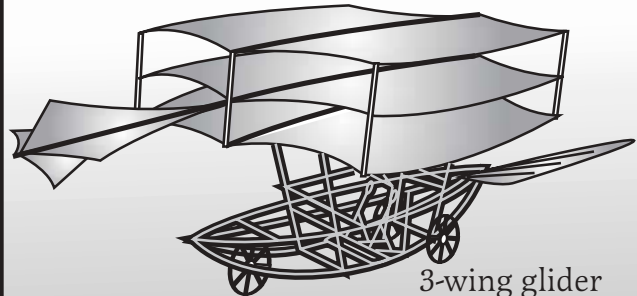

3-wing glider
Sir George Cayley
1849

1850-1899



Lilienthal glider
1891

1900-1949

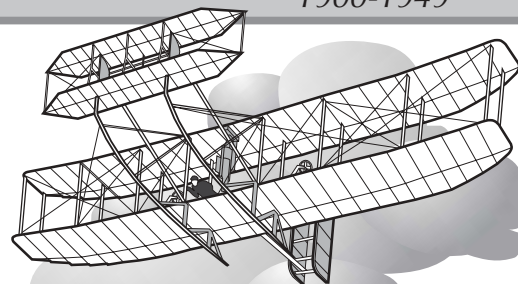

First motor-powered airplane flight
Wright brothers
1903





Time Line

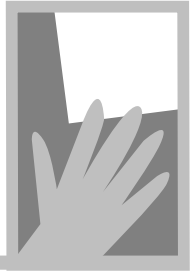

1900-1949

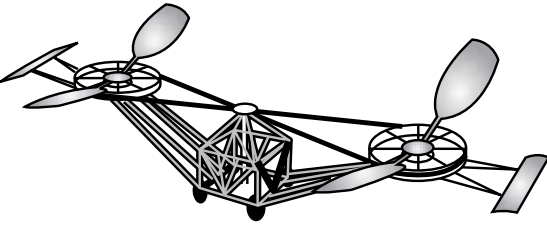

First helicopter
Paul Cornu
1907

1900-1949

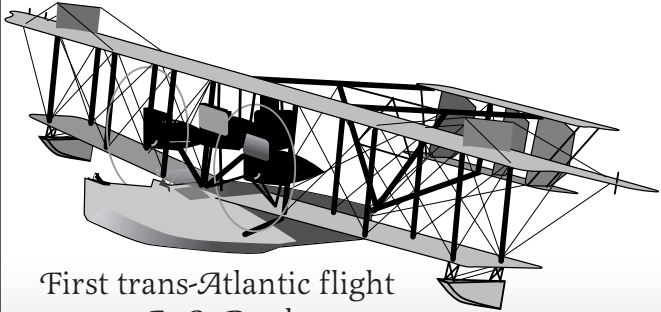

First trans-Atlantic flight
A. C. Reed
1919

1900-1949



First non-stop
flight across Atlantic
Charles Lindbergh
1927

1900-1949

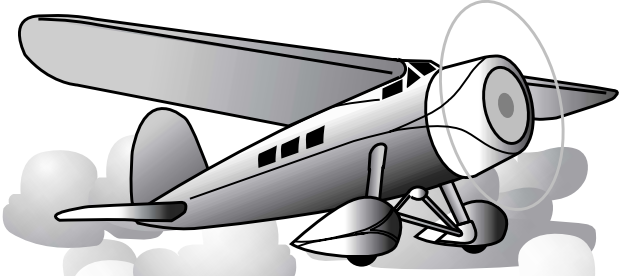

First solo flight Hawaii-California
Amelia Earhart
1935

1900-1949

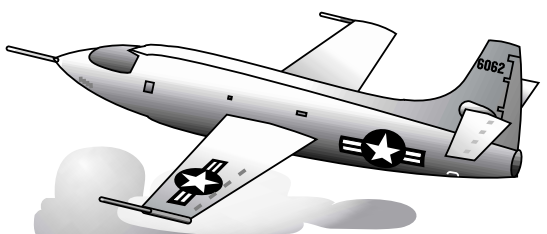

First human flight faster than sound
Chuck Yeager
1947

1950-2000

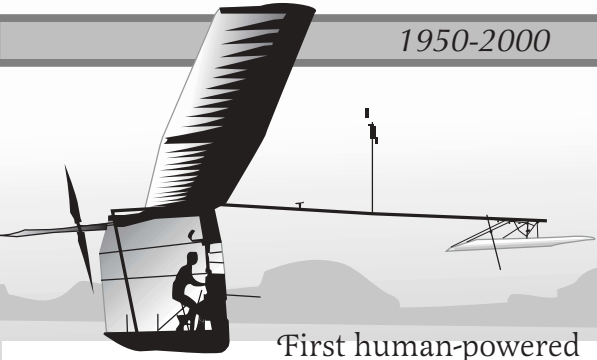

First human-powered
flight across English Channel
Bryan Allen
1979





Time Line

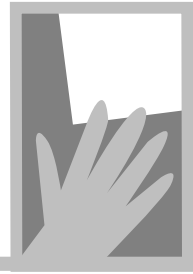

1950-2000

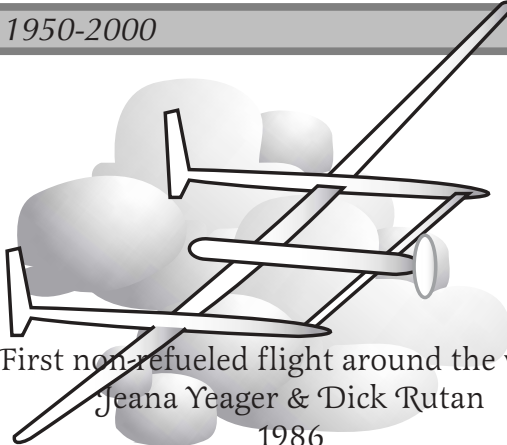

First non-refueled flight around the world
Jeana Yeager & Dick Rutan
1986

Add to the time line by researching other aeronautical events, or design events of the future.

1950-2000



First solar-powered aircraft to fly above the troposphere
NASA/AeroVironment
1997

2000-2050

1900-1949

1950-2000



WHERE IS NORTH? THE COMPASS CAN TELL US...

Objectives

The students will:
Build a compass.
Determine the direction of north, south, east, and west.

Standards and Skills

Science

Science as Inquiry
Physical Science
Earth and Space Science
Science and Technology

Science Process Skills

Observing
Inferring
Making Models

Mathematics

Connections
Verifying and Interpreting Results
Prediction

Background

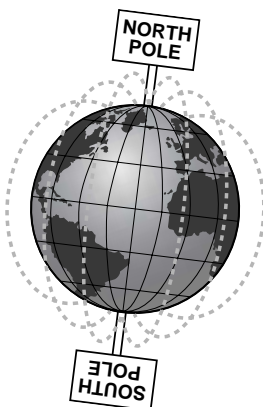

The compass has been used for centuries as a tool for navigation. It is an instrument that aligns a free pivoting bar magnet (called the needle) in Earth's magnetic field.

Since the invisible lines of the magnetic field are oriented in a north/south direction, the needle will orient itself in a north/south direction. The other cardinal points of the compass (east, west, and south) are defined in relation to north.

Pilots use a compass to determine direction when flying airplanes. Boaters, hikers, and hunters are examples of other people who rely on compasses.

Materials

Paper clips
Fourpenny (4p) finishing nail
Shallow dish or pan 15-30 cm diameter
Liquid soap
Magic markers
Styrofoam cup, .25 L capacity
Scissors
Magnet

Management

Students can participate in this activity in a variety of ways:

1. Students can build a single class compass.
 2. Teams of 3-5 students can build team compasses.
 3. Students can build individual compasses.
-

Activity

1. Fill a shallow dish with water.
2. Cut the bottom out of the cup and float it on the water.
3. Place one drop of liquid soap in the water. This will reduce the surface tension friction and will keep the Styrofoam disk from attaching itself to the container wall.
4. Magnetize the compass "needle" by rubbing it in one direction on a small magnet.

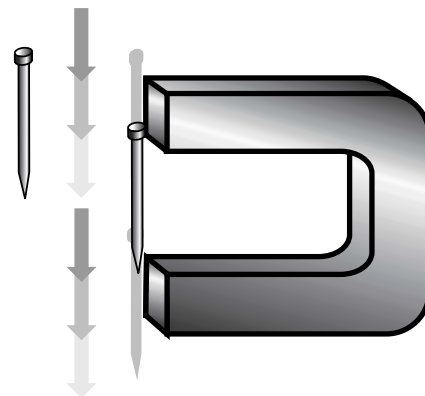
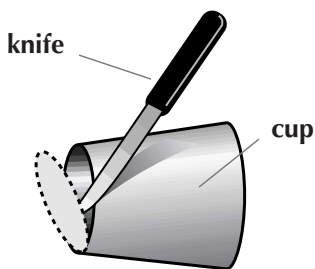
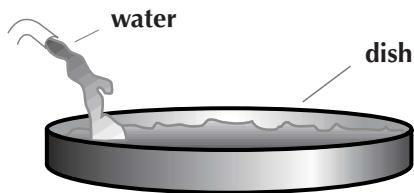

magnetizing nail

5. Place the magnetized compass needle on the floating Styrofoam disk. To minimize compass errors, place the compass away from metals, magnets, or electrical wiring.
6. Ask students to observe the compass needle as it aligns parallel with the invisible magnetic field.
7. Discuss ways to verify which end of the needle is pointing north and which end is pointing south. (Sunrise, sunset, shadows, commercial compass).
8. Place a piece of metal near the compass and observe changes in the needle orientation.
9. Write or cut the letter N and position to indicate the north direction. Follow this by placing the letters S, E, and W around the edges of the compass.

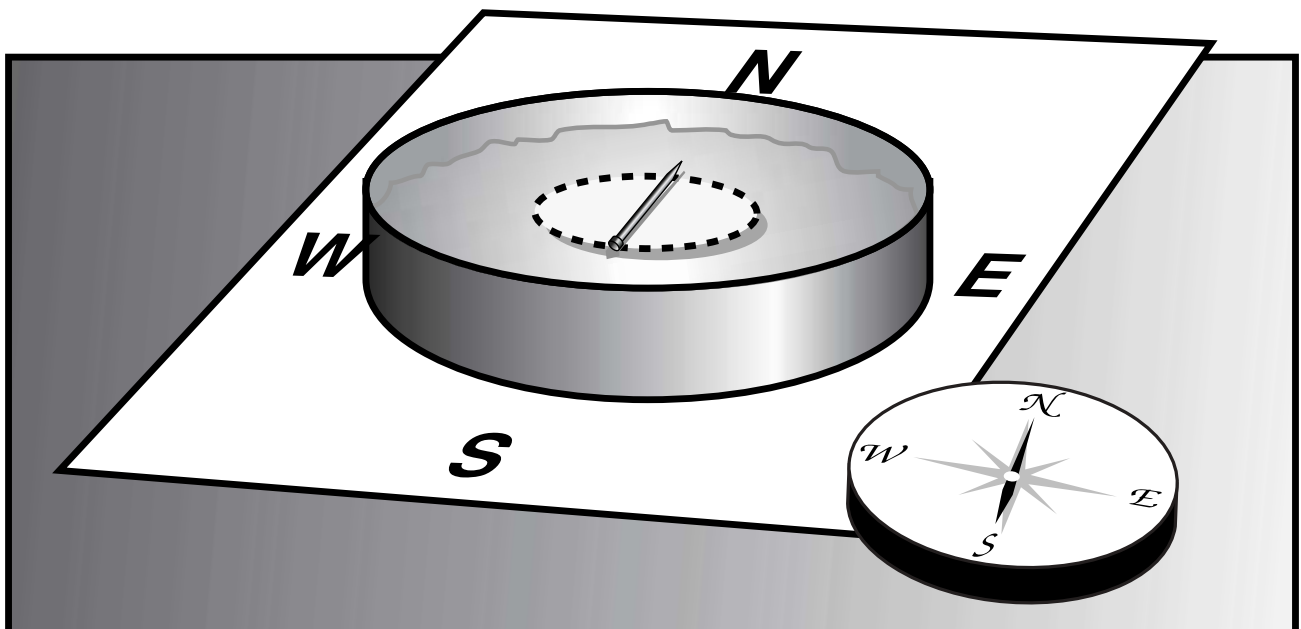

Assessment

Identify an object in the classroom and ask students to state what direction the object is from the compass.

Extensions

1. Hide "prizes" at different locations in the classroom. Have students locate the prizes using a compass while following teacher's directions (north, south, southeast, etc.).
2. Name different areas of the school, and have students determine the area's cardinal direction (north, south, etc.).

Where is North?

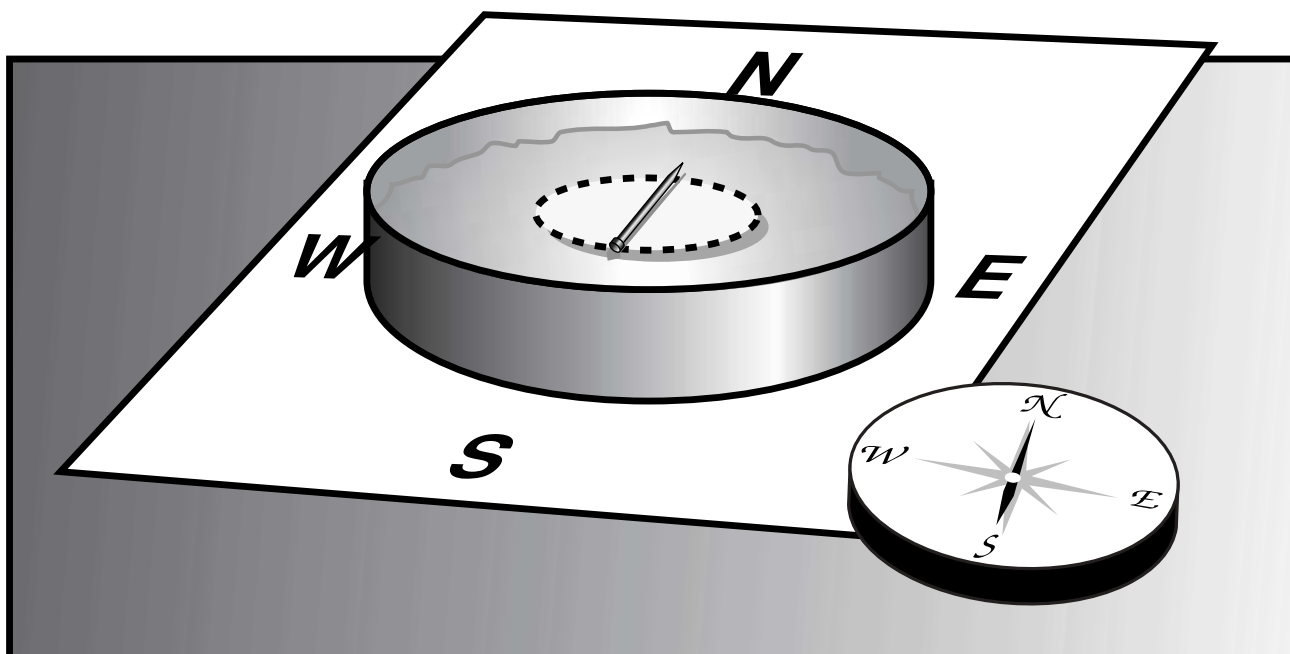
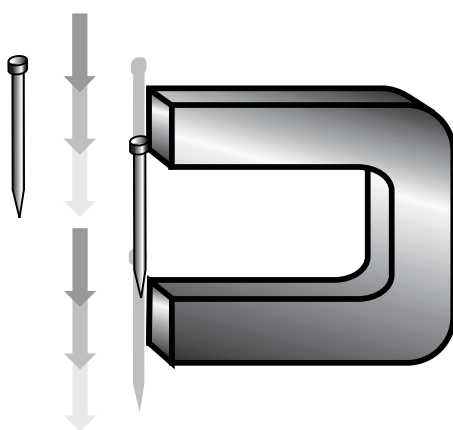
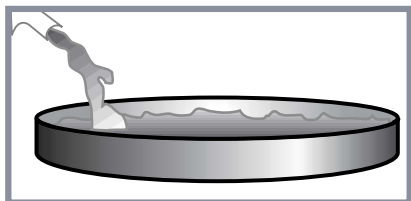
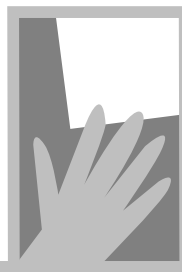

LET'S BUILD A TABLE TOP AIRPORT

Objectives

The students will:
Design and build a model airport.
Learn the components of an airport.
Use the model to demonstrate airport operations.

Standards and Skills

Science

Science and Technology
Science in Personal and Social Perspectives

Science Process Skills

Measuring
Making Models
Investigating
Communicating

Mathematics

Communication
Reasoning

Background

A model airport can provide students with an accurate representation of a real airport. Real airports provide a place for airplanes to takeoff and land. Many communities have small airports to serve small or general aviation airplanes.

Some cities have large airports with long runways to accommodate commercial airline service. All airports have certain things in common such as one or more *runways*, *hangars*, a wind sock, and a *taxiway*. Larger airports have parking lots and passenger terminals.



Buildings at airports serve many different purposes and needs. Buildings where airplanes are stored and maintained are called hangars. The terminal is a building where passengers can get flight information and buy tickets. Other types of businesses found at an airport may include *flight instruction*, the sale of fuel, aircraft parts, and pilot supplies.

The construction of a model airport will help students identify and understand problems that face architects and planners of real airports. Models allow planners to identify potential problems with airport location, layout, and design before expensive construction begins.

Materials

Table approximately 2 m by 1 m or larger
Small miscellaneous boxes (shoe box size)
Thin cardboard
Markers
Masking tape
Bulletin board paper
Model airplanes, cars, and trucks

Preparation

Provide a table to simulate a site in the community where students can start construction of a model airport. Multiple airport models can be constructed by teams.

Explain that an airport location requires flat terrain unobstructed by buildings, trees, and towers. Also mention that airports need to be located away from residential areas because of noise factors.

Activity

1. Cut and place a long, narrow rectangular piece of bulletin board paper on the table to represent the location of a runway. Label this component of an airport.
2. Place several model airplanes at the airport site. The model airplanes can be brought from home, made in class from paper, or cut out of magazines. Discuss with the students the potential hazard to airport operations if airplanes are parked on a runway. Ask students to suggest a safe and accessible place to park airplanes.



3. Cut and place bulletin board paper on the table to represent airplane parking ramps. Label the parking ramp. Place the model airplanes on the ramp.
4. Provide a place on the airport grounds to park the cars and trucks that bring people to the airport. Place model cars and trucks in the parking lot.
5. Small boxes can be used as buildings for the model airport. Label each type of building (terminal building, hangar) or write a business name on the building. Construct and place the hangars that will be used for airplane service, maintenance, and storage. Label the hangar.
6. Provide a facility at the airport to fuel airplanes.
7. Name the airport.

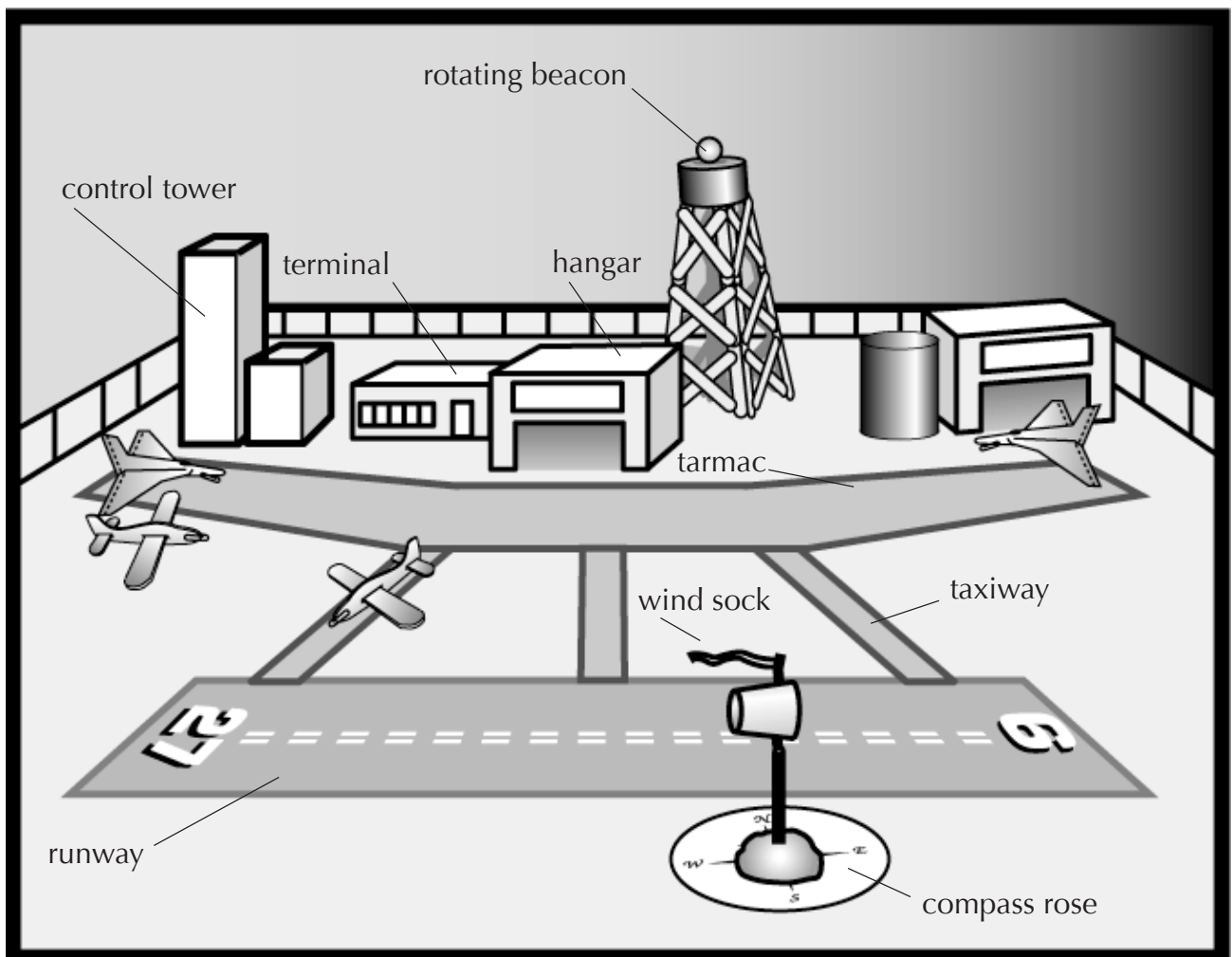

Assessment

1. Invite other students, teachers, or school officials to view and identify the model.
2. Ask a student to role-play the manager of the new model airport, providing a tour of the facility to a group of citizens. The student should use correct terminology to describe the airport.
3. Have a student simulate the first or inaugural takeoff and landing from the new airport using a model airplane. Ask the student to describe the event from a pilot's perspective.

Extensions

1. Using modeling clay, pencil, Styrofoam cup, and paper clip, build a model wind sock for the airport (see illustration).
2. Use a compass to draw a "compass rose" at the airport site.
3. Ask five (5) or more students to take off from the airport with their model airplanes. Have them "fly" to a destination in the classroom and return to the airport for landing. Ask student observers to describe what method the pilots used to avoid hitting each other. Discuss reasons why real airports designate flight patterns for pilots to use. Why is it important that pilots communicate with each other during a flight?
4. Busy airports (controlled airports) employ air traffic controllers to direct flight operations. Pilots are required to have radio contact with the control towers to receive takeoff and landing instructions. This method helps to ensure safe operations. Have a student air traffic controller direct flight operations at the model airport.
5. Runway numbers are based on magnetic direction. For example, if an airport runway is numbered 27, it is aligned in a direction of 270 degrees (it points west). Number the runways on the model airport.
6. Airplanes always try to takeoff and land into the wind. Place a small electric fan on the table to test the wind sock. Use the information from the wind sock to decide which runway to use.
7. Visit a local airport with the students to see how it is arranged.

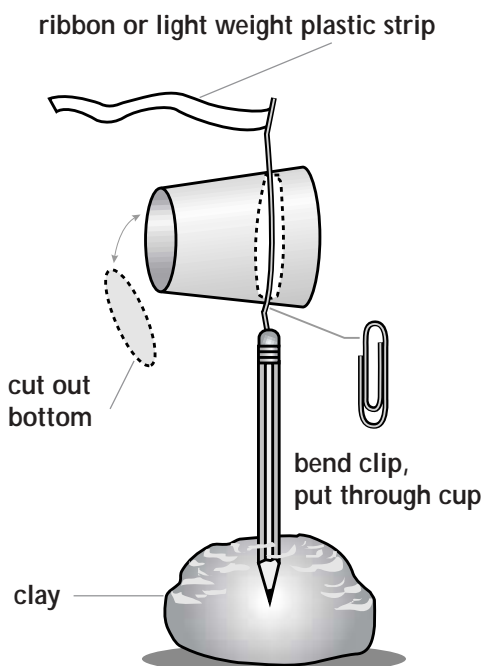



Table Top Airport

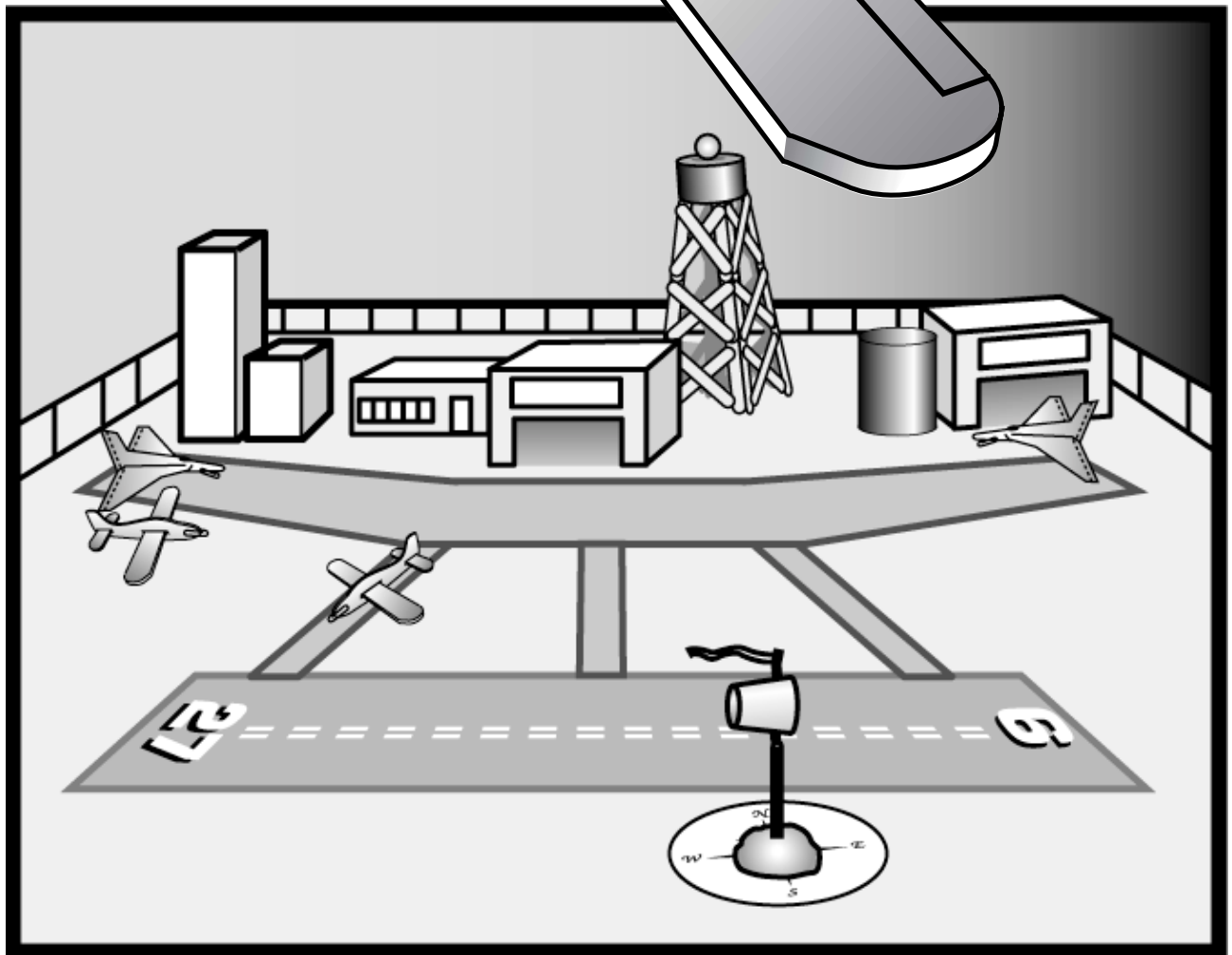
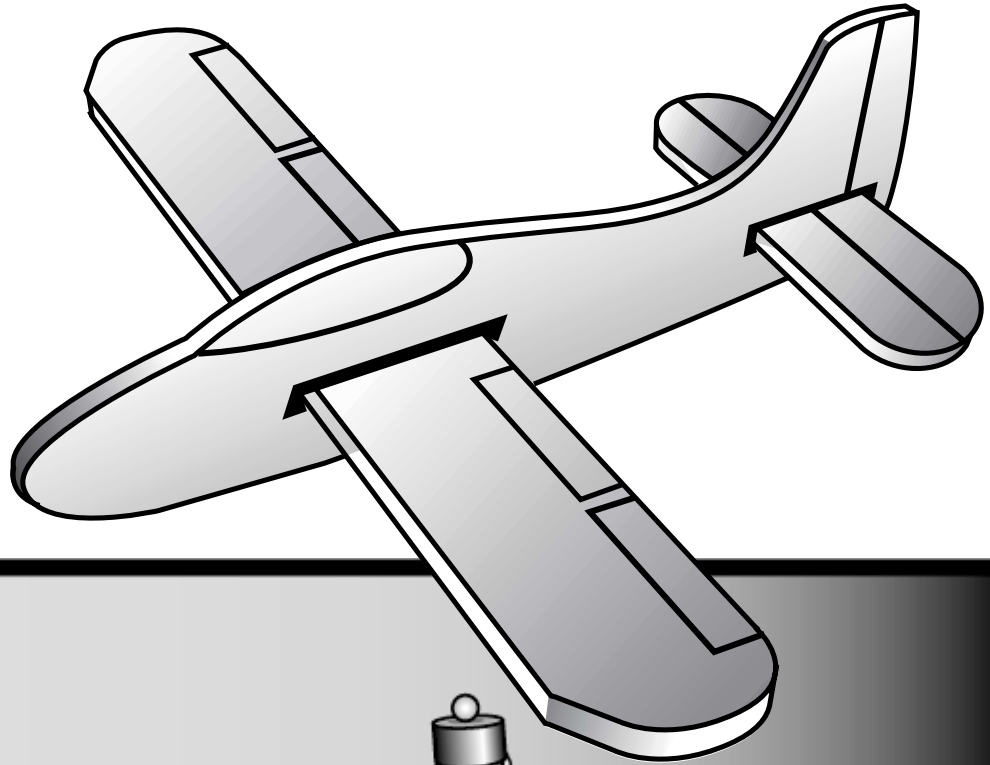
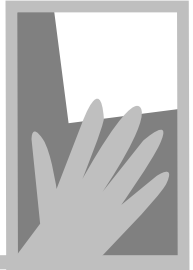
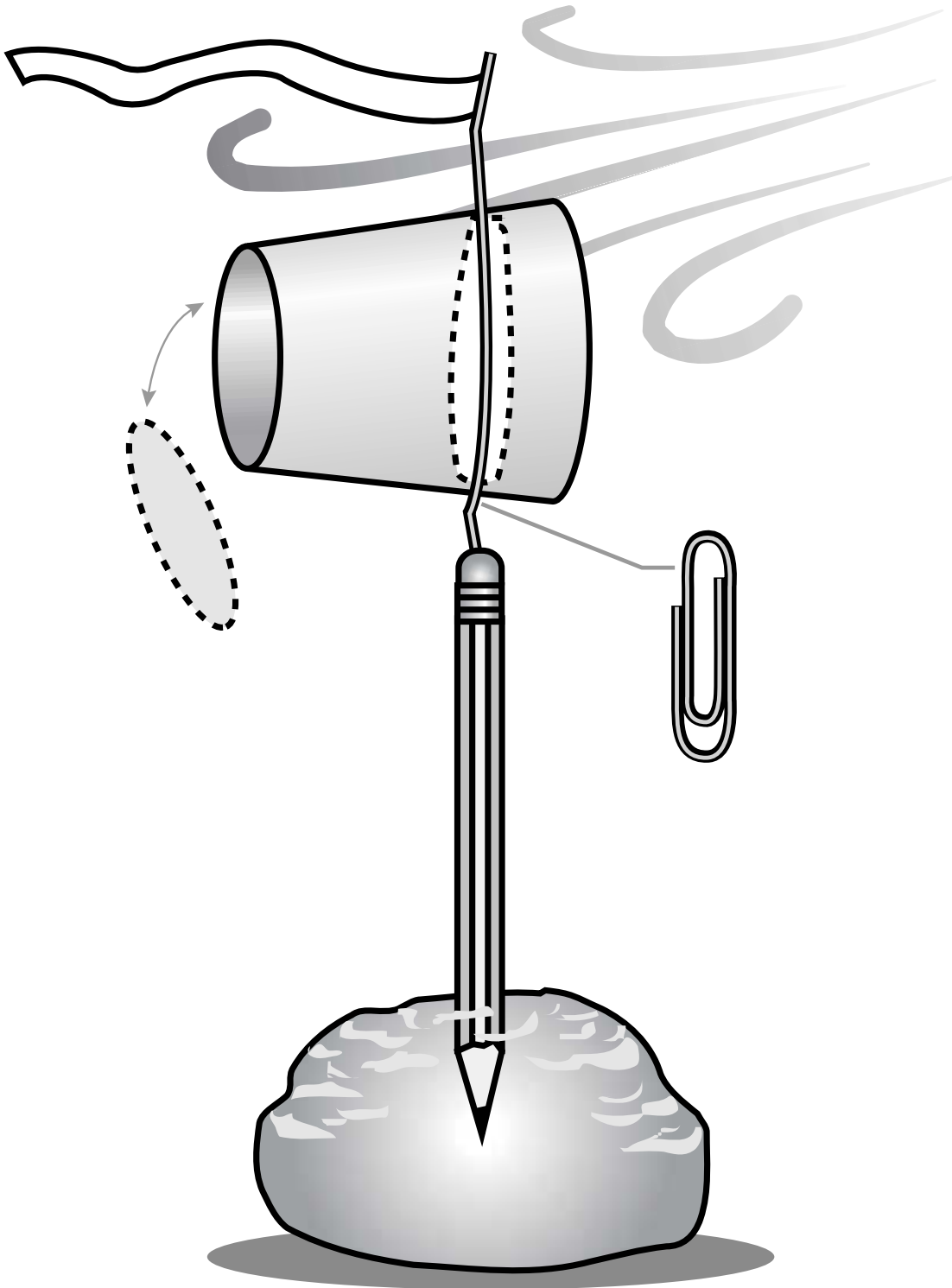
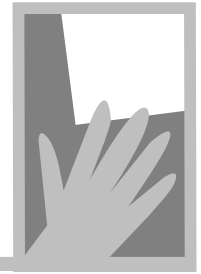



Table Top Airport



PLAN TO FLY THERE



Objectives

The students will:
Create a simple flight plan.
Role-play the communication process pilots use.
Identify the components of a flight plan.
Determine a quantity by using a map scale.

Standards and Skills

Science

Physical Science

Science Process Skills

Communicating

Measuring

Mathematics

Problem Solving

Communication

Connections

Background

It would be very difficult to build a house without a plan. A builder depends on the plan to provide information about the design and size of a house under construction. Plans can also be used to describe an action or sequence of events such as planning for a celebration.

The pilot of an airplane depends on a *flight plan* to provide information to help ensure a successful flight to a destination. The plan may contain the following information:

1. Aircraft number (identification)
2. When the flight will leave (departure time)
3. Where the plane will takeoff from (departure point)
4. How it will get there (route of flight)
5. Where it will land (destination)



-
6. How long it will take to fly there (estimated time en route)
 7. When the flight will land (estimated time of arrival)
 8. Color of the airplane
 9. The pilot's name

Abbreviations and codes are used on flight plans to save space and reduce the number of words. For example, the code for San Francisco International Airport in California would appear on the flight plan as SFO.

The pilot plans the route of flight by connecting a series of points on an *aeronautical chart*. These points are abbreviated, and are listed on the flight plan to describe the route of flight.

Pilots use a radio or telephone to communicate or "file" flight plan information with a Flight Service Station.

Once the airplane is airborne, *Air Traffic Control (ATC)* controllers use the information on flight plans to help track airplanes, and to maintain a safe distance between airplanes.

Talking on a radio or telephone can sometimes change the sound of words and letters. For example the letter B sounds like the letter P and the letter C sounds like the letter D. Most of the information on the flight plan is abbreviated or coded using letters and numbers. To help eliminate mistakes caused by a change in the sound of a letter, pilots use the *International Phonetic Alphabet*.

The International Phonetic Alphabet assigns word sounds to every letter in the alphabet. Instead of saying the letter A, pilots say the word Alpha. The code SFO would be stated Sierra Foxtrot Oscar.

Materials

Barrier (a screen, portable chalkboard, bookcase, etc.)
Paper and pencil
Noise source (radio static simulated by crumpling cellophane)
Copies of student Flight Plans
Copies of student Aero-Charts
Radios or walkie-talkies (optional)



Preparation

Make copies of the Student Pages for each student.
Student Pages can be used to prepare students for this activity.

The Aero-Chart Student Page is used as a work sheet by the students to determine such factors as departure airport, destination airport, route of flight, and flying time in hours. Students complete the Flight Plan Student Pages by answering questions on the form.

Different airplanes travel at different speeds. Pilots determine the time en route based upon the cruising speed of their airplane. Students determine how long it will take to fly a route by using the icon at the bottom of the chart to scale the time. The length of one icon equals 1 hour flying time in the airplane. Example: If the course is 5 icons in length, it will take 5 hours to fly the distance. The students decide the departure time and add the flying time to determine arrival time at the destination airport.

The students can role-play the communication of flight plans between pilot and air traffic controller. Set up listening stations with chairs on either side of the barrier and have the students talk to each other in a normal voice level. If walkie-talkies are available, students could be in different rooms.

Introducing background noise near the stations can simulate real world problems pilots have when communicating with radios. Radio transmissions are sometimes unclear because of static or interference, which can change phonetic sounds.

Activity

1. Hand out a copy of the Aero-Chart and of a flight plan to each student. (Students can work in pairs or small groups for this activity.)
2. Ask the students to choose any departure and destination airport shown on the chart.
3. Ask the students to mark a route between the two airports by connecting the lettered dots. Write the route on the flight plan. Note: Routes do not have to be “direct” to an airport. Consider what might influence the choice of a particular route; examples include mountain avoidance, restricted areas, flight time limits because of fuel tank capacity, and sight-seeing en route.



-
- Using the time icon (located at the bottom left corner of the Aero Chart Student Page), have the students determine the amount of time the flight will take. Enter this in the flight plan.
 - Ask the students to decide on a departure time and add the flight time to determine the arrival time. Add this information to the flight plan.
 - Have the students complete the flight plan by adding an aircraft identification and pilot's name.
 - To simulate talking on a telephone or radio, divide the students into pairs with a barrier between them. Ask one student in each pair to "transmit" the flight plan information to the other student and have them write down the information as they receive it.
 - The students can exchange flight plans to see if the information matches.

Discussion

- What would you do if you had to communicate with Air Traffic Controllers in Italy? *The international language for air traffic control is English. Controllers in Italy and most countries communicate using the English language.*
- Do pilots have to use a flight plan? *Pilots are required to use flight plans certain types of flights. For example, pilots flying commercial airliners are required to use flight plans. Many other pilots use flight plans voluntarily for safety reasons; if a flight plan is not cancelled on time, government agencies are notified so search and rescue operations may begin to locate the pilot and airplane filed on the flight plan.*
- Can pilots change a flight plan? *Yes, flight plans can be changed by talking to a Flight Service Station.*

Extensions

- Have students plan a flight route using a chart they create.
- Invite a pilot to the classroom to talk about flight plans.
- Have students draw a picture of what they would see on an airplane flight over a city or farm.
- Have the student spell his or her name using the phonetic alphabet.



-
5. Prominent landmarks such as radio towers, race tracks, and mountains are depicted on aeronautical charts to help pilots navigate. Pilots also use landmarks to specify their location when communicating on the radio to flight controllers and air traffic. Have students review the route of their flight and describe how they used landmarks to navigate.
 6. Have students identify local landmarks that pilots could use for navigation.

Assessment

1. Have the students complete a flight plan using the International Phonetic Alphabet.
2. Ask the students to create a chart scale for distance.
3. Create a walk/bike plan to describe how a student could get to a friend's house.
4. Create a travel plan for getting to school.





Plan to Fly There

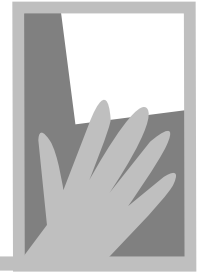

International Phonetic Alphabet

A	ALPHA	N	NOVEMBER
B	BRAVO	O	OSCAR
C	CHARLIE	P	PAPA
D	DELTA	Q	QUEBEC
E	ECHO	R	ROMEO
F	FOXTROT	S	SIERRA
G	GOLF	T	TANGO
H	HOTEL	U	UNIFORM
I	INDIA	V	VICTOR
J	JULIET	W	WHISKEY
K	KILO	X	X-RAY
L	LIMA	Y	YANKEE
M	MIKE	Z	ZULU



Plan to Fly There

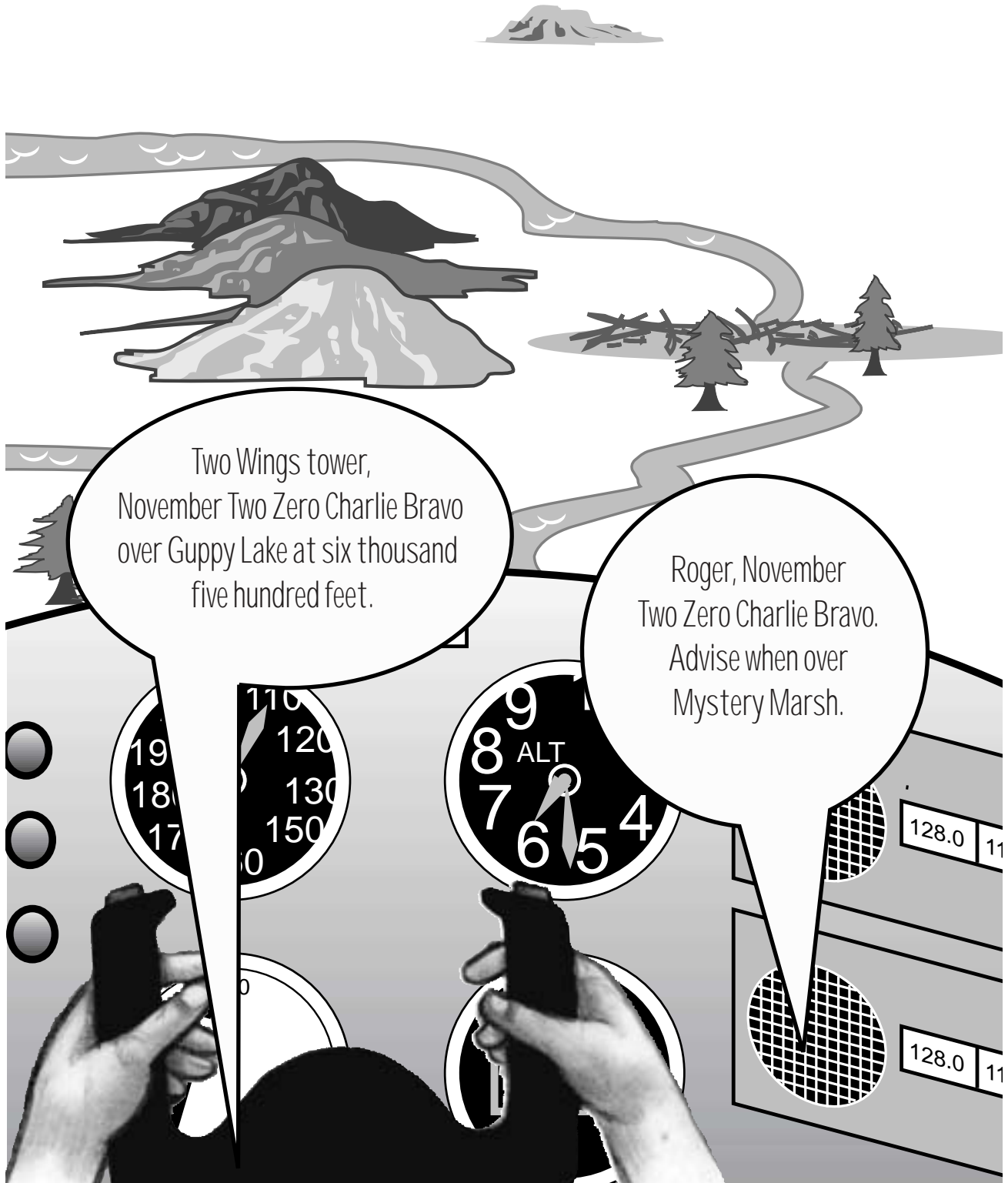
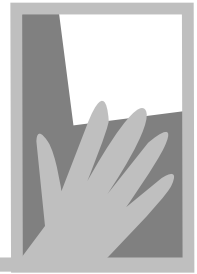

Plan to Fly There

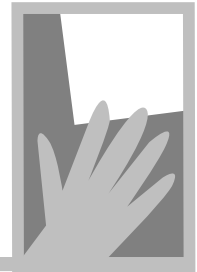

Aero-Chart

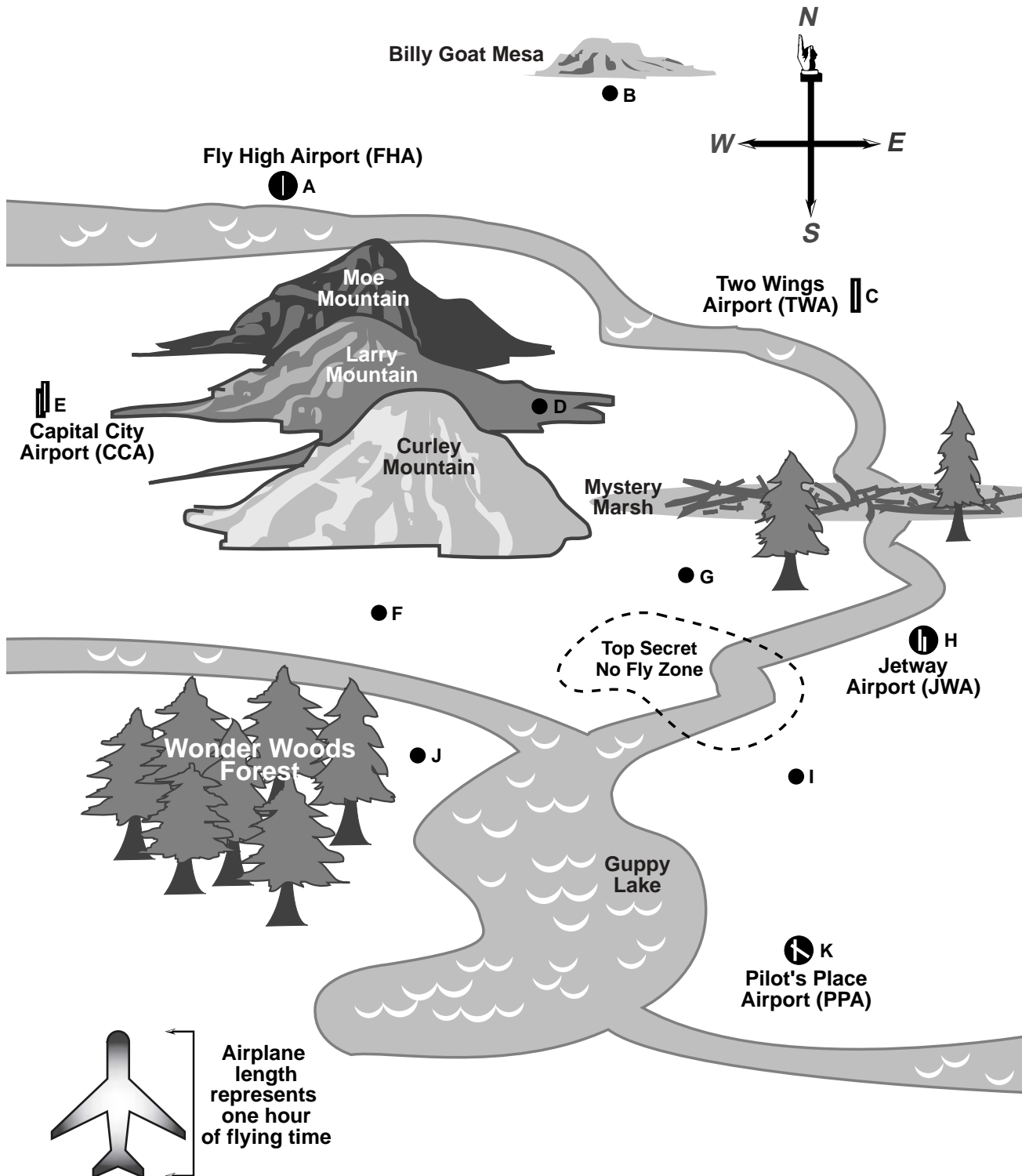



Plan to Fly There

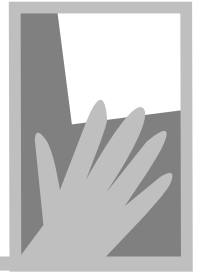

Directions

1. Look at the Aero-Chart Student Page and use it as a worksheet to help plan your trip.
2. Use the Aero-Chart to answer some of the questions on the flight plan below.
3. Fill in the blank spaces on the form to create a flight plan.

Aircraft Identification

1. What is my airplane's number?

Departure Time

2. What time will we leave?

Departure Airport

3. From what airport will we leave?

Route of Flight

4. How will we get there?

Destination of Trip

5. Where will we land?

Estimated Time En Route

6. How many hours will it take to get there?

Arrival Time

7. What time will we land?

Aircraft Color

8. What color is my airplane?

Name of Pilot

9. What is my name?





Plan to Fly There

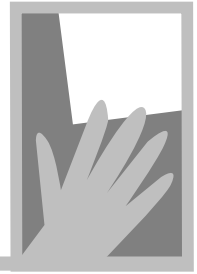

Official Pilot's Flight Plans

Pilot's Flight Plan

Aircraft Number _____ Departure Time _____
Departure Point _____

Route of Flight _____
Destination _____

Estimated Time En Route _____ Arrival Time _____
Color of Aircraft _____

Name and Address of Pilot

Pilot's Flight Plan

Aircraft Number _____ Departure Time _____
Departure Point _____

Route of Flight _____
Destination _____

Estimated Time En Route _____ Arrival Time _____
Color of Aircraft _____

Name and Address of Pilot



WE CAN FLY, YOU AND I

INTERDISCIPLINARY LEARNING ACTIVITIES

Science

- Create a classroom model of an airport terminal.
- Collect and interpret weather maps from the local newspapers.
- Discuss what kinds of science would be important for pilots to study and understand. Why?
- Discuss why weather is an important factor for aircraft to fly safely.
- List and discuss environmental concerns when constructing a new airport in any community.

Mathematics

- Discuss what the numbers on a runway mean.
- If traveling to different times zones, determine what the local time will be when reaching the destination.
- Make a graph comparing the distances flown by the rotor motor, bag balloon, and delta wing glider.
- Determine how many years elapsed between different time line events.

Technology Education

- Discuss technology that contributes to airport safety.
- Discuss the importance of computers on aircraft and in airports.

Fine Arts

- Make a mobile using aviation as a theme.
- Design or draw the layout of an airport.
- Design art that depicts what airports will look like in the future.



Social Studies

- Undertake a field trip to the local airport.
- Create an advertisement to market your privately owned airline.
- Debate possible locations for a new airport in your community.
- Research the history of your local airport.
- Invite airport employees, or pilots, to speak to students about their careers in aviation/aerospace.
- Discuss careers available in the aviation field.
- Interview airport employees.
- Research the development of airports. How have airports changed?

Language Arts

- Write an imaginary conversation between the control tower and pilot.
- Fill out a logbook as if you were a pilot for an airline.
- Role-play as a newspaper reporter at a major historical aviation event.
- Write a story about an aviation-related job.
- Imagine you are a pilot or navigator; you just completed an adventurous flight, and you are describing the flight for a television news program.

Health/Physical Education

- Discuss the feelings experienced when flying in an airplane.
- Determine how long it will take to walk or run the distance of a typical airport runway (.6 - 3.0 km).
- Determine how many students standing shoulder-to-shoulder it takes to equal the wingspan of these aircraft: 747 airliner (60.3 m wingspan), F-15 Eagle (13.2 m wingspan), and X-15 rocket airplane (6.8 m wingspan).



Appendix

<i>The Parts of an Airplane</i>	110
<i>Aeronautical Glossary</i>	111
<i>Suggested Reading</i>	115
<i>NASA Resources for Educators</i>	118



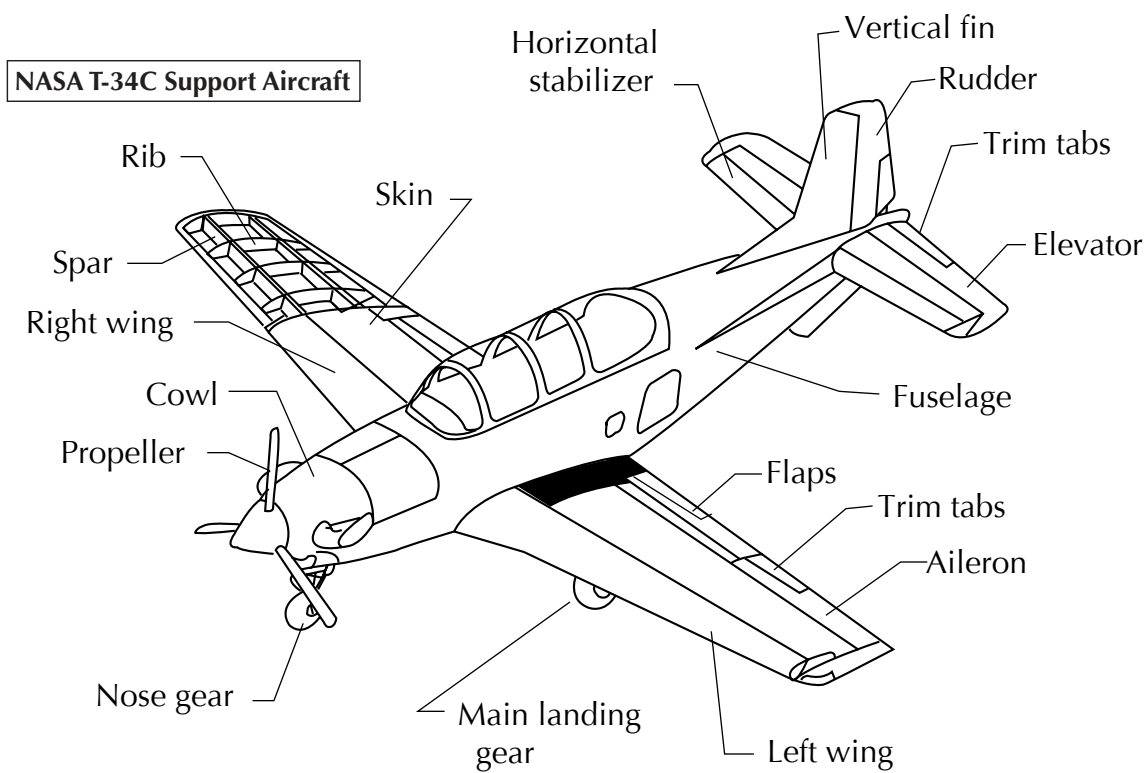

The Parts of an Airplane

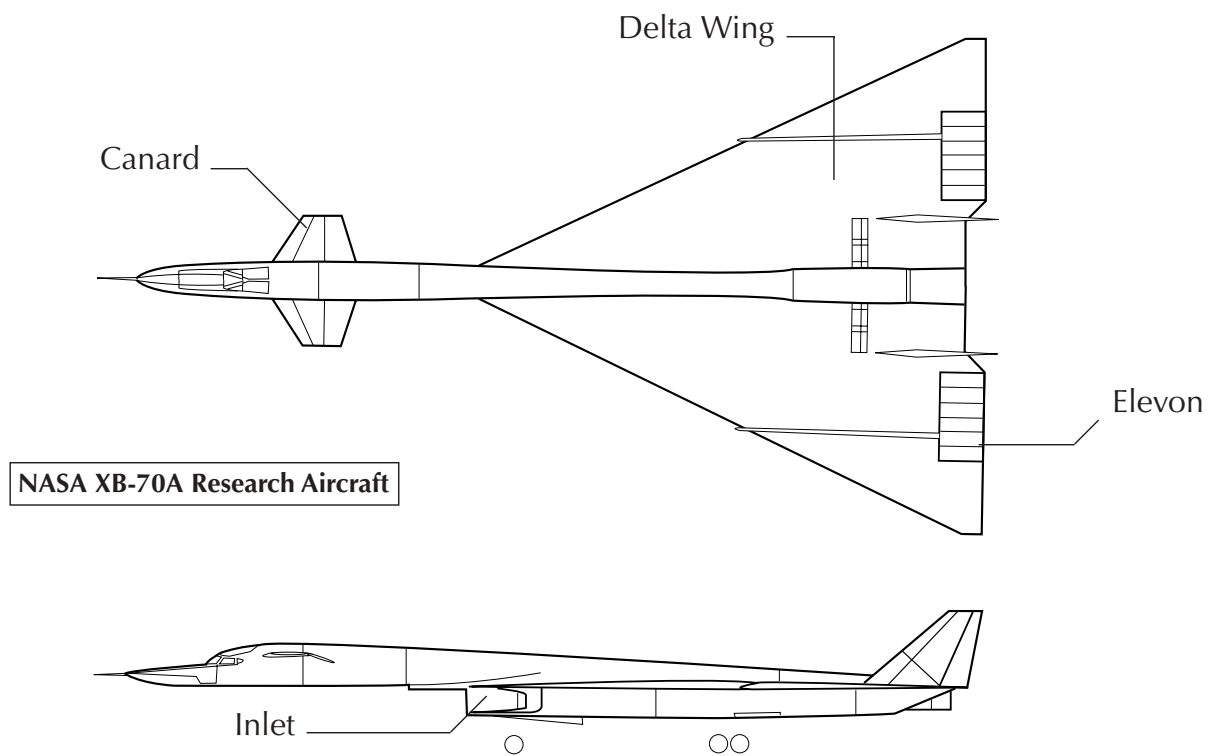

Aeronautical Glossary

aeronaut: One who flies balloons.

aeronautical chart: A map designed for aerial navigation. Aeronautical charts include information about airports, ground elevations, landmarks, airspace designations, routes to fly, and other aids to navigation. Aeronautical charts are regularly revised to provide current information.

airfoil: An aerodynamic surface shaped to obtain a reaction from the air through which it moves; for example, wing, rudder, aileron or rotor blade.

aerodynamics: The branch of science that deals with the motion of air and the forces on bodies moving through the air.

aileron: Control surface, traditionally hinged to outer portion of the wing and forming part of the trailing edge, that provides control in roll as well as in banking the wings into a turn.

angle of attack: An engineering term that describes the angle of an aircraft's body and wings relative to its actual flight path. It is also called alpha. High angles of attack (greater than about 10 degrees) are called high alpha.

angle of incidence: While angle of attack varies during flight, angle of incidence is fixed with the design of the aircraft. Airfoils are generally attached to the aircraft at a small angle in relation to its longitudinal axis.

aspect ratio: The ratio between the length of a wing and its width (chord). Short, stubby wings (as on most jets) have a low aspect ratio; long, narrow wings (as on gliders) have a high aspect ratio.

ATC: Air traffic control. A system that controls air traffic from airport locations. Air traffic personnel on the ground use two-way communication with aircraft crews to maintain the safe flow of aircraft in airport vicinities, and to direct aircraft on routes between airports.

attitude: The orientation of the three major axes of an aircraft (longitudinal, lateral, and vertical) with respect to a fixed reference such as the horizon, the relative wind, or direction of flight. Usually refers to the relationship between the nose of the airplane and the horizon, such as the nose is pointing "above" or "below" the horizon.

canard: Canard has a couple of meanings. It is an aircraft with the horizontal stabilizer placed ahead of the wing instead of behind it on the tail, and it also refers to a forward horizontal stabilizer. Some aircraft have canards in addition to a conventional horizontal stabilizer on the tail.

composite: Usually refers to a type of structure made with layers of fiberglass or fiberglass-like materials such as carbon fiber. The materials are called composites.

digital-fly-by-wire: A flight control system whereby instead of mechanical links (cables and pulleys) from the cockpit to the aircraft's flight controls, wires carry electronic signals. These electric/electronic signals allow a pilot to "fly by wire." Digital refers to digital computer inputs in the system; some fly-by-wire systems use analog computers. Virtually all modern, fly-by-wire flight control systems are digital. The acronym is DFBW.

drag: Resistance of a vehicle body to motion through the air. A smooth surface has less drag than a rough one.

elevator: A movable horizontal airfoil, usually attached to the horizontal stabilizer on the tail, that is used to control pitch. It usually changes the attitude of the nose, making it move up and down.

elevon: Elevons are moveable control surfaces located on the trailing edge of the wings to control pitch and roll. Working in unison (both up or both down), they function as elevators. Working differentially (one up and one down), they function as ailerons.

fin: Another term for the vertical stabilizer (see vertical stabilizer).



flaps: Hinged, pivoted, or sliding airfoils or plates (or a combination of them) normally located at the trailing edge of the wing. They are designed to increase the wing's lift or otherwise improve an airplane's slow-flight characteristics.

flight controls: Moveable surfaces on the aircraft that control its path through the air.

flight plan: Specific information about the intended flight of an aircraft that is delivered orally or in writing with air traffic control.

flight instruction: Instruction in airplanes, and on the ground, by a person who has been certified with the Federal Aviation Administration to teach flying.

fly-by-wire: see digital-fly-by-wire.

fuselage: The main structural body of an aircraft to which the wings, tail unit, etc. are attached.

G or g: A symbol used to denote gravity or its effects. Also used as a unit of stress measurement for bodies undergoing acceleration, or the "loads" imposed on an aircraft and pilot. Loads may be centrifugal and aerodynamic due to maneuvering, usually expressed as g, i.e. 7 g is a load seven times the weight of the aircraft.

glider: An aircraft that does not use an engine for thrust. Gliders typically have relatively long, narrow wings (compared to powered aircraft) for maximum lift and minimum drag. A high lift-to-drag (glide) ratio allows the plane to fly a longer distance horizontally for every foot that it descends. High performance gliders, also known as sailplanes, can glide more than six-times the distance an average powered airplane can glide with its engine not operating.

hangar: A building used to house aircraft.

helicopter: A flying machine (heavier-than-air) that uses motor-driven rotors for support in the air. These rotors also provide the main force to propel it horizontally. A rotorcraft.

horizontal stabilizer: Loosely, a fixed, horizontal tail surface, but on many supersonic aircraft the entire horizontal stabilizer moves to control pitch.

hypothesis: A hypothesis is a proposed answer to a problem, or an explanation that accounts for a set of facts and that can be tested by further experimentation and observation. The results of experimentation provide evidence that may or may not support the hypothesis.

inlet: Usually, openings that let air into a jet engine.

International Phonetic Alphabet: A system of words identifying the letters of the alphabet and numbers. The system was reached through international agreement, and uses words chosen for their ease of pronunciation by people of all language backgrounds.

lift: The sum of all the aerodynamic forces acting on an aircraft at right angles to the flight path. When the aircraft is in steady level flight the lift is equal and opposite to the weight of the aircraft. Wings create lift.

lifting body: An aircraft that uses the shape of its body to generate lift instead of using wings.

Mach number: The speed of the aircraft (true air speed) divided by the speed of sound at a given temperature. Loosely, it is the speed in terms of the speed of sound, i.e. Mach 1 is the speed of sound, Mach 2 is twice the speed of sound, etc.

meteorologist: A weather forecaster. A person knowledgeable in the field of meteorology, which is a branch of science that deals with the physical properties of the atmosphere. Meteorology deals with the way weather conditions develop and change.

NACA: National Advisory Committee for Aeronautics, NASA's predecessor, 1915 to 1958.

ornithopter: A flying machine that is supposed to support itself in the air through the use of flapping wings.



pitch, pitch attitude: Loosely, the angle between the nose of an aircraft and the horizon. The nose pitches “up” or “down” in relation to level flight. It is different from angle of attack, which is the wing’s angle relative to the aircraft’s flightpath.

ramjet: A jet engine with no mechanical compressor, consisting of specially shaped tubes or ducts open at both ends. The air necessary for combustion is shoved into the duct and compressed by the forward motion of the engine.

roll: The rotation of an aircraft about its longitudinal axis. An aircraft is turned by controlling roll and yaw. A turn is initiated by “rolling” the wings into the direction of the turn. Once the turn is established, the rolling movement is stopped. A roll in the opposite direction of the turn is used to stop the turn.

rotors: The airfoils that are used by helicopters; they are rotated at high speeds to produce lift and thrust.

rotor blades: Also known as rotors.

rotary wing aircraft: Also known as rotorcraft. An aircraft (heavier-than-air) that uses rotating airfoils (rotary wings) to produce aerodynamic lift.

rudder: The primary control surface in yaw (side-ways movement), it is usually hinged and attached to the trailing edge of the vertical stabilizer on an aircraft’s tail.

runway: A surface on the ground specifically used for aircraft takeoffs and landings.

shock wave: An aircraft generates a shock wave as it flies faster than the speed of sound, pushing air molecules aside like a boat creates a bow wave. The shock wave forms a cone of pressurized air molecules which moves outward and rearward in all directions and extend to the ground.

solar-powered aircraft: Solar-powered aircraft, such as the Pathfinder, use photovoltaic cells to convert energy from the sun into electricity to power electric motors that drive the aircraft.

sonic boom: The thunder-like noise a person on the ground hears when an aircraft flies overhead faster than the speed of sound. The boom is caused by the sudden change in air pressure with the passage of a shock wave.

stall: A flight condition wherein the airflow separates from the airfoil surface, or the airflow around the airfoil becomes turbulent, causing the airfoil to lose lift. It is usually a result of insufficient airspeed or excessive angle of attack.

straight-wing: A wing that is approximately perpendicular to the fuselage.

supersonic: Faster than the speed of sound (about 750 mph at sea level).

swept-wing: A wing that has a visibly obvious, backwards or forwards inclination relative to the fuselage. The adjective swept-wing describes an aircraft that has wings which sweep forward or sweep back. Some aircraft have the ability of sweeping the wings while in flight; these wings are called variable sweep wings.

taxi way: An airport road (used primarily for the movement of aircraft) connecting the runway to hangars, terminals and other airport locations.

thrust: A force that propels an aircraft forward. Rocket and jet engine “power” is referred to in “pounds of thrust.”

tiltrotor: A rotor that is tilted from a horizontal alignment (as a helicopter) for takeoff and landing, to a vertical alignment (as an airplane) for level flight. Tiltrotor aircraft typically have the tiltrotors mounted on the tips of airplane-like wings, and achieve the flight characteristics of airplanes and helicopters.

transonic: Speeds slightly above and below the speed of sound.



vertical stabilizer: Sometimes referred to as a vertical fin, or fin, it is a vertical or inclined airfoil, usually at the tail or wing tip to increase directional stability. Sometimes the rudder is hinged to it.

weight and balance: A term referring to the distribution of weight in an aircraft and the location of its center of gravity. The center of gravity is the point where the weight is balanced. Proper weight and balance are essential for the safe operation of an aircraft.

wind tunnel: Tubular structures or passages, in which high-speed movements of air or other gases are produced. Objects such as engines or aircraft, airfoils, and rockets (or models of these objects) are placed inside of the wind tunnel so researchers can investigate the airflow around them and the aerodynamic forces acting upon them.

wing loading: Gross weight of an aircraft divided by the area of the wing. Aircraft that have proportionally large wings are said to be “wing-loaded,” while those with smaller wings, such as most jet fighters, are said to be “fuselage loaded.”

winglet: Small, nearly vertical, winglike surface mounted above the wing tip to reduce drag.

wing warping: A means to control aircraft roll by twisting (warping) the aircraft’s wing tips. The Wright brothers used wing warping on their early gliders, and on their first powered aircraft. Although wing warping was discontinued in favor of ailerons on most aircraft since 1910, the concept is still considered valid for special applications on advanced aircraft.

yaw: A flight condition of an aircraft in which the aircraft rotates about its vertical axis. Yawing is different from turning because an aircraft can be yawed while flying straight with the wind striking it from the side. An aircraft follows a curved flight path when turning, with the wind always flowing parallel to its longitudinal axis.

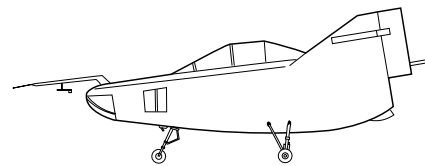

M2-F1 1963

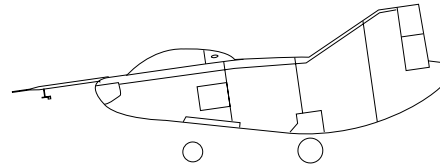

M2-F2 1966

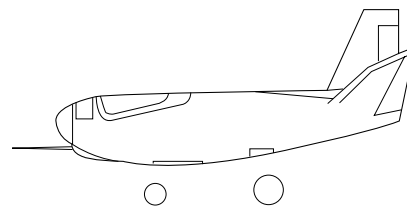

HL-10 1966

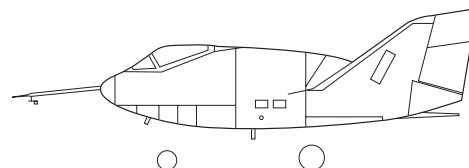

X-24A 1969

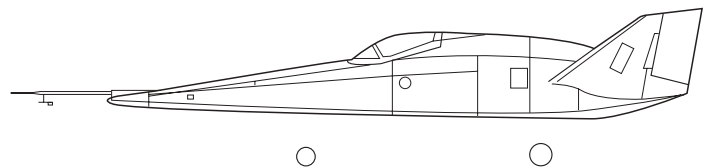

X-24B 1972

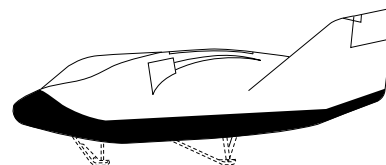

X-38 1998

NASA Wingless Research Aircraft



Suggested Reading

These books can be used by children and adults to learn more about aeronautics. The lists also include aviation-based fiction suitable for young readers.

Teacher activity books:

- Aviation & Space Science Projects.* (1992). Blue Ridge Summit, PA. ISBN: 0-8306-2156-3.
- John Bringham. 1994. *Oddballs, Wing-flappers & Spinners Great Paper Airplanes.* Summit, PA: Tab Books. ISBN: 007067910X.
- E. Richard Churchill. 1990. *Fantastic Flying Paper Toys.* NY, NY: Sterling Publication, Co. ISBN: 0-8069-7460-5.
- Great American Airplanes.* (1992). Bellerophon Books. Santa Barbara, CA: Bellerophon Books. ISBN: 0-88588-113-6.
- Edward H. Mathews. 1992. *Super Endurance Paper Planes.* NY, NY: St. Martin's Press. ISBN: 0-312-08314-9.
- A. G. Smith. 1986. *History of Flight Coloring Book.* Mineola, NY: Dover Publications, Inc. ISBN: 0-486-25244-2.

Books for students and educators:

- Jon Agee. 1994. *Return of Freddy Legrand, The.* NY, NY: Farrar, Strauss, & Giroux, Inc. ISBN: 0-374-46230-5.
- Lee J. Alnes. 1977. *Draw 50 Airplanes, Aircraft and Spacecraft.* NY, NY: Doubleday. ISBN: 0-385-23629-8.
- American Heritage History of Flight, The.* 1962. NY, NY: American Heritage Publishing Company. LCCN: 62-17517
- Mark Arceneaux. 1974. *Paper Airplanes.* Los Angeles, CA: Troubador Press. ISBN: 0-8431-1703-6.
- Isaac Asimov, Elizabeth Kaplan. 1993. *How Do Airplanes Fly?* Milwaukee, WI: Gareth Steven's, Inc. ISBN: 0-8368-0800-2.
- Renzo Barto, Judith Conaway. 1987. *Things That Go! How to Make Toy Boats, Cars, and Planes.* Mahwah, NJ: Troll Associates. ISBN: 0-8167-0839-8.
- Judith Bauer. 1990. *What's it Like to be an Airline Pilot.* Mahwah, NJ: Troll Communications. ISBN: 0-8167-1791-5.
- Cynthia Benjamin. 1997. *Working Hard With the Rescue Helicopter.* Scholastic (Tonka). ISBN 0-590-13449-2.
- Don Berliner. 1989. *World Aerobatics Championships, The.* Minneapolis, MN: Lerner Publications Company. ISBN: 0-8225-0531-2.
- Rob Bolster, Jerry Pallotta, Fred Stillwater. 1997. *Airplane Alphabet Book, The.* Watertown, MA: Charlesbridge Publishing. ISBN: 0-88106-907-8.
- Eileen Browne. 1993. *No Problem.* Cambridge, MA: Candlewick Press. ISBN: 1-56402-200-5.
- Caroline Castle, Peter Weevers. 1986. *Herbert Binns & The Flying Tricycle.* NY, NY: Dial Books for Young Readers. ISBN: 0-8037-0041-5.
- Tomie dePaola. 1975. *Cloud Book, The.* NY, NY: Holiday House. ISBN: 0-8234-0531-1.
- Frank Evans. 1994. *All Aboard Airplanes.* NY, NY: Grosset & Dunlap. ISBN-448-40214-9.
- Sarah Ferguson. 1989. *Budgie: The Little Helicopter.* NY, NY: Simon & Shuster. Books for Young Readers. ISBN: 0-671-67683-0.
- Roy Gerrard. 1992. *Jocasta Carr, Movie Star.* NY, NY: Farrar, Strauss, & Giroux. ISBN: 0-374-43777-7.
- Gail Gibbons. 1989. *Catch the Wind: All About Kites.* NY, NY: Little, Brown & Co. ISBN: 0-316-30955-9.
- David Glover. 1993. *Flying & Floating.* NY, NY: Kingfisher Books. ISBN: 1-85697-937-7.
- George W. Gray. 1948. *Frontiers of Flight, the Story of NACA Research.* Alfred A. Knopf, New York. LCCN: 48000713.
- Thomas G. Gunning. 1992. *Dream Planes.* NY, NY: Dillon Press. ISBN: 0-87518-556-8.
- Philip S. Hart. 1992. *Flying Free: America's First Black Aviators.* Minneapolis, MN: Lerner Publications, Co. ISBN: 0-8225-1598-9.
- Barbara Hayes, Phillip Mendoza. 1986. *Up, Up and Away.* NY, NY: Modern Publishing. ISBN: 0-87449-044-8.
- Mark Hewish. 1976. *Usborne Young Scientist: Jets.* London, England: Usborne Publishing Ltd. ISBN: 0-86020-051-5.
- How To Draw Wings & Wheels.* (1994). Chicago, IL: Kid's Books, Inc. ISBN: 1-56156-223-8.
- Brian S. Hurst, Olivia Newton-John. 1993. *Pig Tale, A.* NY, NY: Simon & Schuster Books for Young Readers. ISBN: 0-671-78778-0.



- Donald Jade Jackson. 1980. *The Aeronauts*. Morristown, NJ: Time-Life Books. ISBN: 0809432684.
- Terry Jennings. 1993. *Planes, Gliders, Helicopters & Other Flying Machines*. NY, NY: Kingfisher Books. ISBN: 1-85697-869-9.
- Gallimard Jeunesse. 1992. *Airplanes & Flying Machines*. USA: Cartwheel Books. ISBN: 0-590-45267-3.
- Neil Johnson. 1991. *Fire & Silk: Flying in a Hot Air Balloon*. Boston, MA: Little, Brown & Co. ISBN: 0-316-46959-9.
- Robin Kerrod. 1992. *Amazing Flying Machines*. NY, NY: Alfred A. Knopf Books for Young Readers. ISBN: 0-679-92765-4.
- Andrew Kershaw. 1992. *Super Facts Aircraft*. NY, NY: Derrydale Books. ISBN: 0-517-07324-2.
- Remi Kramer. 1994. *Legend of Lonestar Bear Book II: Soaring with Eagles, The*. Sandpoint, ID: Northwind Press. ISBN: 0-945887-14-0.
- Kate Little. 1987. *Things That Fly*. Tulsa, OK: EDC Publishing. ISBN: 0-7460-0104-5.
- Donald Lopez. 1995. *Flight*. Alexandria, VA: Time-Life Books. ISBN: 0-7835-4761-7.
- Dan Mackie. 1986. *Flight, Discover Planes, Hanggliders & Ultralights*. Burlington, Ontario, Canada: Hayes Publishing. ISBN: 0-88625-112-5.
- Doug Magee, Robert Newman. 1992. *Let's Fly From A to Z*. NY, NY: Cobblehill Books. ISBN: 0-525-65105-5.
- Jerry Mander. 1967. *Great International Paper Airplane Book, The*. NY, NY: Simon & Schuster, Inc. ISBN: 0-671-21129.
- Giovanna Mantegazza. 1994. *Look Inside an Airplane*. NY, NY: Grosset & Dunlap. ISBN: 0-448-40545-1.
- Michael Martchenko, Robert Munsch. 1988. *Angela's Airplane*. Buffalo, NY: Alnick Press. ISBN: 1-55037-026-X.
- Christopher Maynard. 1995. *Airplanes. (Mighty Machines Series.)* Dorling Kindersley. ISBN: 0-7894-0211-4.
- Christopher Maynard. 1994. *Incredible Flying Machines*. NY, NY: Covent Garden Books. ISBN: 1-56458-552-2.
- Christopher Maynard. 1993. *Little Library: Helicopters*. NY, NY: Kingfisher Books. ISBN: 1-85697-893-1.
- Nina McGuire, Sandra Wallus. 1997. *Jacqueline Cochran, America's Fearless Aviator*. Sammons. Tailored Tours Publications. ISBN: 0-9631241-6-1.
- Michael McKeevar, Georgeanne Irvine. 1991. *Day in the Life of a Test Pilot*. A. Mahwah, NJ: Troll Associates. ISBN: 0-8167-2224-2.
- Campbell Morris. 1986. *Best Paper Aircraft, The*. NY, NY: Perigee Books. ISBN: 0-399-51301-9.
- Gary Moser. 1993. *Fly: A Brief History of Flight, Illustrated*. Steven's Point, WI: Worzolla Printing. ISBN: 0-06-022893-8.
- Chris Oxlade. 1996. *Action Pack Flight*. NY, NY: D. K. Publishing, Co. ISBN: 07894-1006-0.
- Tim Paulson. 1992. *How to Fly a 747*. NY, NY: W. W. Norton. ISBN: 1-563261-061-9.
- Alice and Martin Provensen. 1983. *Glorious Flight Across the Channel with Louis Bleriot, The*. NY, NY: Viking Press. ISBN: 0-670-34259-9.
- Edith Rumhardt. 1987. *Airplane Book*. Racine, WI: Western Publishing, Co. ISBN: 0-307-10083-9.
- Margret and H. A. Rey. 1986. *Curious George Flies a Kite*. Boston, MA: Houghton Mifflin Co. ISBN: 0-395-25937.
- Francene Sabin. 1983. *Amelia Earhart Adventure in the Sky*. Mahwah, NJ: Troll Associates. ISBN: 089575-840.
- K. Scarborough. 1993. *How it Goes: Helicopters*. Hauppauge, NY: Barron's Educational Series, Inc. ISBN: 0-8120-1993-8.
- Huck Scarry. 1991. *Big Book of Things That Go*. NY, NY: Barnes & Noble Books. ISBN: 1-56619-588-8.
- Richard Scarry. 1992. *Planes*. NY, NY: Western Publications, Co. ISBN: 0-307-11555-6.
- Mick Sellar. 1992. *Air, Wind & Flight*. NY, NY: Shooting Star Press. ISBN: 1-56924-008-6.
- Margret Rey, Alan J. Shallick. 1987. *Curious George at the Airport*. NY, NY: Scholastic, Inc. ISBN: 0-590-42186-7.
- Kaydon Stanzione. 1995. *Alyssa, Albert, & the Magic Plane*. Woodbury, NJ: Praxis-Tech. Corp. ISBN: 1-887602-10-0.
- Michael Teitelbaum. 1991. *First Facts about Flying Machines*. Chicago, IL: Kidsbooks, Inc. ISBN: 1-56156-086-3.
- Finch C. Volney, USN Retired. 1931. *Preparing for Aviation*. Simmons-Boardman Publishing Company.



A. Ward. 1981. *Usborne Pocket Scientist: Flight and Floating: Safe Experiments to do at Home*. London, England: Usborne Publishing Ltd. ISBN: 0-86020-529-0.

David Wiesner. 1992. *June 29, 1999*. Clarion Books. ISBN: 0-395-59762-5.

Mike Wimmer. 1991. *Flight*. NY, NY: Philomel Books. ISBN: 0-399-22272-3.

Martin Woodward. 1996. *Airplanes: A Foldout Book*. USA: Rand McNally. ISBN: 052885723-0.

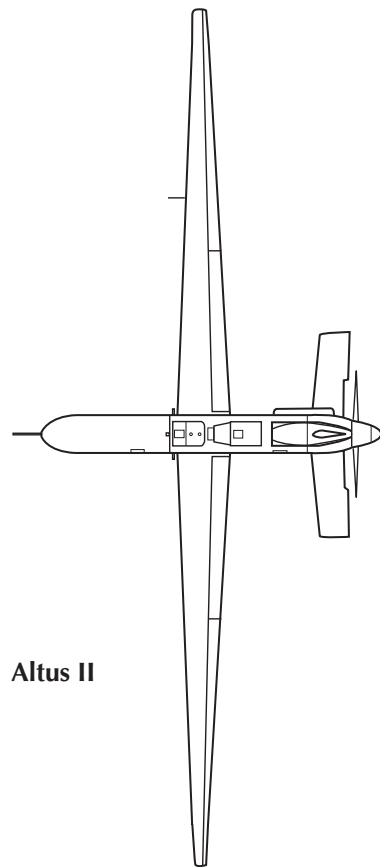

Altus II

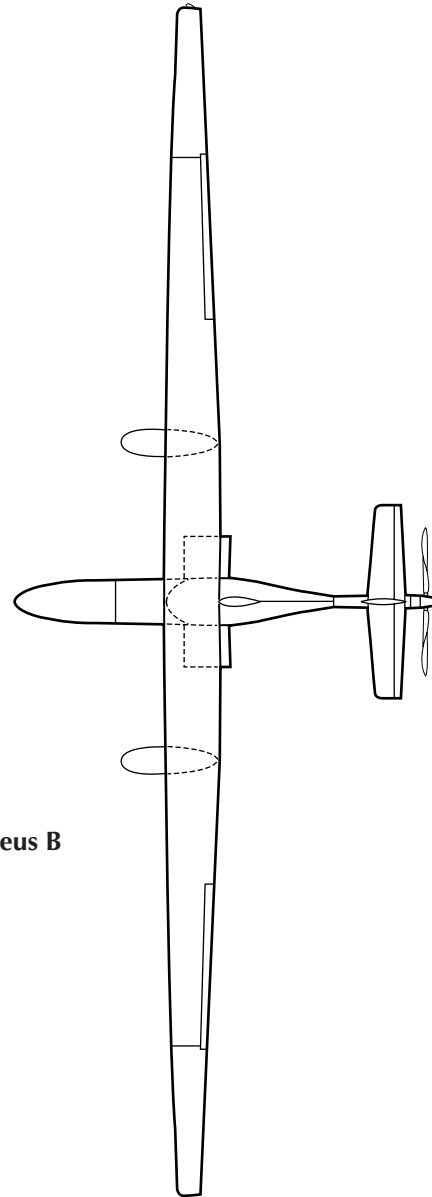

Perseus B

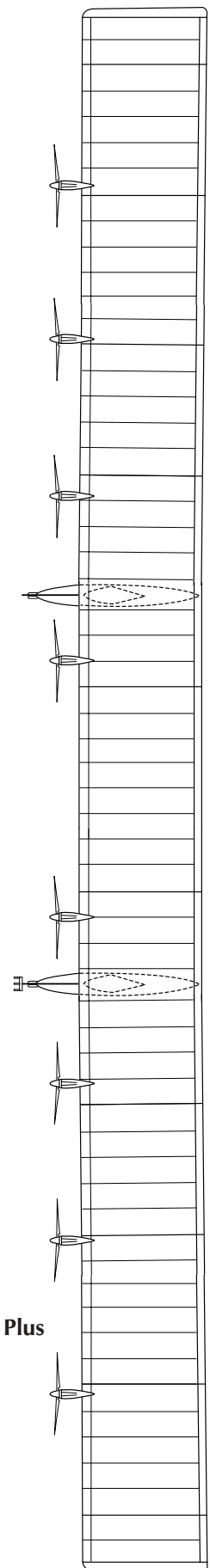

Pathfinder Plus

NASA Remotely-piloted Environmental Research Aircraft 1998

NASA is developing several aircraft capable of flying for days at a time, at altitudes over 20,000 m, to conduct research of the earth's environment. The Altus II and Perseus B aircraft are powered by a rear-mounted piston engine and propeller. The Pathfinder Plus uses front-mounted, solar-powered electric motors and propellers. (The depicted aircraft are scaled proportionally. The Pathfinder Plus wingspan is 36.57 m.)

NASA Resources for Educators

NASA's Central Operation of Resources for Educators (CORE) was established for the national and international distribution of NASA-produced educational materials in multimedia format. Educators can obtain a catalogue and an order form by one of the following methods:

NASA CORE
Lorain County Joint Vocational School
15181 Route 58 South
Oberlin, OH 44074-9799
Toll Free Ordering Line: 1-866-776-CORE
Toll Free FAX Line: 1-866-775-1460
E-mail nasaco@leeca.org
Home Page: <http://core.nasa.gov>

Educator Resource Center Network (ERCN)

To make additional information available to the education community, NASA has created the NASA Educator Resource Center (ERC) network. Educators may preview, copy, or receive NASA materials at these sites. Phone calls are welcome if you are unable to visit the ERC that serves your geographic area. A list of the centers and the regions they serve includes:

AK, Northern CA, HI, ID, MT, NV, OR, UT, WA, WY
NASA Educator Resource Center
NASA Ames Research Center
Mail Stop 253-2
Moffett Field, CA 94035-1000
Phone: (650) 604-3574

IL, IN, MI, MN, OH, WI
NASA Educator Resource Center
NASA Glenn Research Center
Mail Stop 8-1
21000 Brookpark Road
Cleveland, OH 44135
Phone: (216) 433-2017

CT, DE, DC, ME, MD, MA, NH, NJ, NY, PA, RI, VT
NASA Educator Resource Laboratory
NASA Goddard Space Flight Center
Mail Code 130.3
Greenbelt, MD 20771-0001
Phone: (301) 286-8570

CO, KS, NE, NM, ND, OK, SD, TX
Space Center Houston
NASA Educator Resource Center for

NASA Johnson Space Center
1601 NASA Road One
Houston, TX 77058
Phone: (281) 244-2129

FL, GA, PR, VI
NASA Educator Resource Center
NASA Kennedy Space Center
Mail Code ERC
Kennedy Space Center, FL 32899
Phone: (321) 867-4090

KY, NC, SC, VA, WV
Virginia Air & Space Center
Educator Resource Center for
NASA Langley Research Center
600 Settlers Landing Road
Hampton, VA 23669-4033
Phone: (757) 727-0900 x 757

AL, AR, IA, LA, MO, TN
U.S. Space and Rocket Center
NASA Educator Resource Center for
NASA Marshall Space Flight Center
One Tranquility Base
Huntsville, AL 35807
Phone: (256) 544-5812

MS
NASA Educator Resource Center
NASA Stennis Space Center
Building 1200
Stennis Space Center, MS 39529-6000
Phone: (228) 688-3338

CA
NASA Educator Resource Center for
NASA Jet Propulsion Laboratory
Village at Indian Hill
1460 East Holt Avenue, Suite 20
Pomona, CA 91767
Phone: (909) 397-4420

AZ and Southern CA
NASA Educator Resource Center for
NASA Dryden Flight Research Center
PO Box 273, M/S 4839
Edwards, CA 93523-0273
Phone: (661) 276-5009 or (800) 521-3416 x 5009

VA and MD's Eastern Shores
NASA Educator Resource Center
GSFC/Wallops Flight Facility
Visitor Center Building J-17
Wallops Island, VA 23337
Phone: (757) 824-2298



Regional Educator Resource Centers offer more educators access to NASA educational materials. NASA has formed partnerships with universities, museums, and other educational institutions to serve as regional ERCs in many states. A complete list of regional ERCs is available through CORE, or electronically via NASA Spacelink at <http://spacelink.nasa.gov/ercn>.

NASA's Education Home Page serves as the education portal for information regarding educational programs and services offered by NASA for the American education community. This high-level directory of information provides specific details and points of contact for all of NASA's educational efforts, Field Center offices, and points of presence within each state. Visit this resource at the following address: <http://education.nasa.gov>.

NASA Spacelink is one of NASA's electronic resources specifically developed for the educational community. Spacelink serves as an electronic library to NASA's educational and scientific resources, with hundreds of subject areas arranged in a manner familiar to educators. Using Spacelink Search, educators and students can easily find information among NASA's thousands of Internet resources. Special events, missions, and intriguing NASA Web sites are featured in Spacelink's "Hot Topics" and "Cool Picks" areas. Spacelink may be accessed at: <http://spacelink.nasa.gov>.

NASA Spacelink is the official home to electronic versions of NASA's Educational Products. A complete listing of NASA Educational Products can be found at the following address: <http://spacelink.nasa.gov/products>.

NASA Television (NTV) features Space Station and Shuttle mission coverage, live special events, interactive educational live shows, electronic field trips, aviation and space news, and historical NASA footage. Programming has a 3-hour block—Video (News) File, NASA Gallery, and Education File—beginning at noon Eastern and repeated four more times throughout the day. Live feeds preempt regularly scheduled programming.

Check the Internet for programs listings at: <http://www.nasa.gov/ntv>

For more information on NTV, contact:
NASA TV
NASA Headquarters - Code P-2
Washington, DC 20546-0001
Phone (202) 358-3572

NTV Weekday Programming Schedules (Eastern Times)

Video File	NASA Gallery	Education File
12-1 p.m.	1-2 p.m.	2-3 p.m.
3-4 p.m.	4-5 p.m.	5-6 p.m.
6-7 p.m.	7-8 p.m.	8-9 p.m.
9-10 p.m.	10-11 p.m.	11-12 p.m.
12-1 a.m.	1-2 a.m.	2-3 a.m.

How to Access Information on NASA's Education Program, Materials, and Services (EP-2000-09-345-HQ)

This brochure serves as a guide to accessing a variety of NASA materials and services for educators. Copies are available through the ERC network, or electronically via NASA Spacelink.

Please take a moment to evaluate this product at http://ehb2.gsfc.nasa.gov/edcats/educator_guide. Your evaluation and suggestions are vital to continually improving NASA educational materials. Thank You.

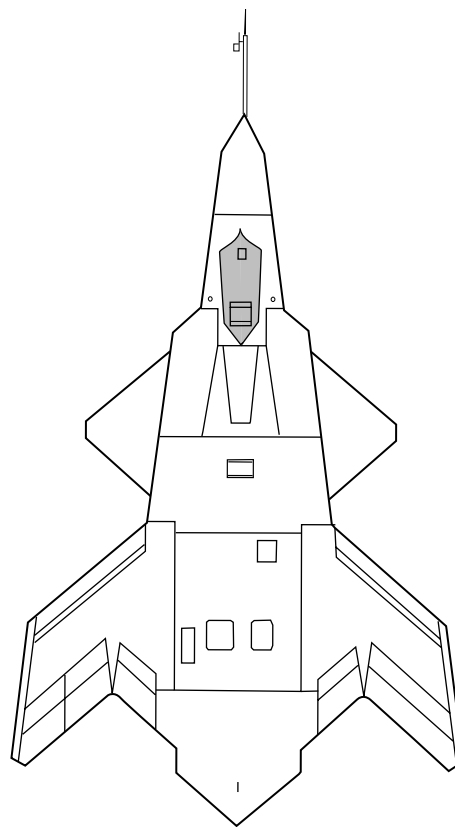

**NASA X-36 Research Aircraft
1997**

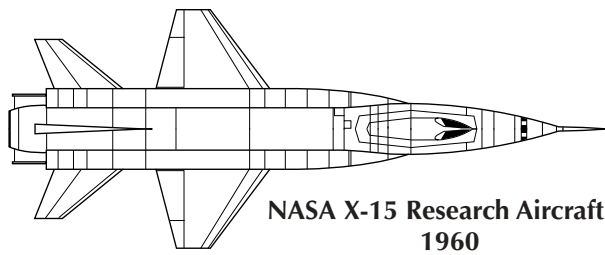

The following listing of Internet addresses will provide users with links to educational materials throughout the World Wide Web (WWW) related to aeronautics and aviation.

NASA Aeronautics Centers

Education Home Pages:

NASA Ames Research Center

<http://education.arc.nasa.gov>

NASA Dryden Flight Research Center

<http://trc.dfrc.nasa.gov>

NASA Langley Research Center

<http://edu.larc.nasa.gov>

NASA Lewis Research Center

<http://www.lerc.nasa.gov/Doc/educatn.htm>

NASA Aeronautics Photographs and Images

Dryden Flight Research Center Photo Gallery. Hundreds of photographs from the 1940's to the present depicting NACA and NASA flight research.

<http://www.dfrc.nasa.gov/gallery/photo/>

NASA Image eXchange (NIX).

A web-based tool for simultaneously searching several NASA image archives on the Internet. NIX searches databases of over 300,000 on-line NASA images.

<http://nix.nasa.gov/>

NASA Multimedia Gallery.

A collection of links to most of NASA on-line video, audio, and photo imagery.

<http://www.nasa.gov/gallery/index.html>

NASA Photo Gallery.

A collection of links to most of NASA still photo imagery available on-line.

<http://www.nasa.gov/gallery/photo/index.html>

Other Aeronautics Education Websites

The National Coalition for Aviation Education.

Provides a list of over thirty member organizations and contacts, including: the Air Line Pilots Association, 4-H Aerospace Educations Programs, the Soaring Society of America, and Women in Aviation, International.

<http://www.aviationeducation.org/>

The K-8 Aeronautics Internet Textbook (K8AIT).

Provides on-line lesson plans, student activities covering subjects that include the principles of aeronautics, and aerodynamics in sports technology. An aeronautics career guide, and tour of NASA projects relevant to K8AIT is also offered.

<http://wings.avkids.com/>

The Aeronautics Sign Language Dictionary.

Provides 3-D animated aviators demonstrating aeronautical terms in sign language.

<http://wings.avkids.com/Book/Signing/>

The U.S. Centennial of Flight Commission provides a wide range of suggestions for how educators can engage their students in celebrating the 100th anniversary of powered flight.

<http://www.centennialofflight.gov/education.htm>

Reliving the Wright Way is a rich resource of information on the Wright Brothers and their process of invention. Designed for use by educators and students, the Web site offers everything from online, interactive demonstrations of how the Wright Flyer worked to a regularly updated calendar of events related to the celebration of the Centennial of Flight.

<http://wright.nasa.gov>



National Air and Space Museum (NASM) - Smithsonian Institution.

The NASM was established to memorialize the development of aviation and space flight, and provide educational materials for the study of aviation.

<http://www.nasm.si.edu/>

United States Air Force Museum Home Page.

The United States Air Force Museum near Dayton, Ohio is the oldest and largest military aviation museum in the world.

<http://www.wpafb.af.mil/museum/>

Planes of Fame Museum.

In addition to information about its collection, this aviation museum in Chino, California is an excellent source of aviation links on-line.

<http://www.planesoffame.org/links.htm>

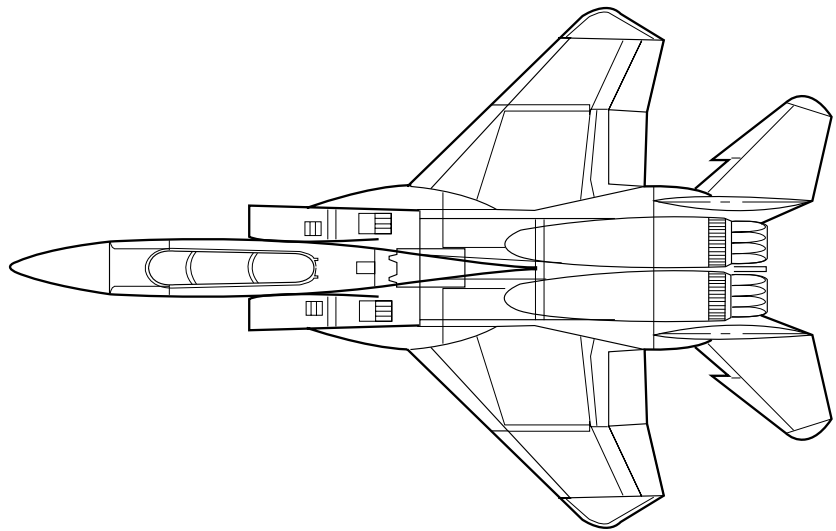

**NASA F-15B Aerodynamic Flight Facility (AFF)
1999**

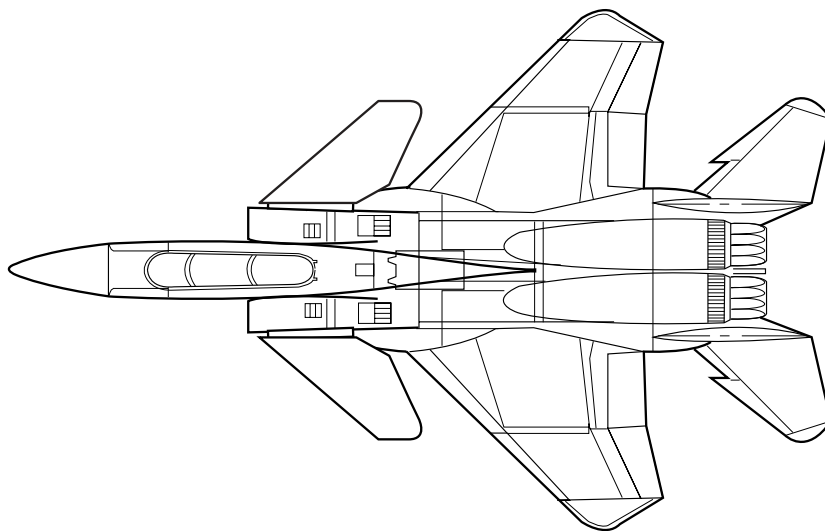

**NASA F-15B Advanced Control Technology for
Integrated Vehicles (ACTIVE)
1999**

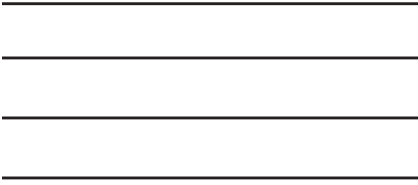

Please Place
Stamp Here
Post Office
Will Not Deliver
Without Proper
Postage

**NATIONAL AERONAUTICS AND SPACE ADMINISTRATION
EDUCATION DIVISION
MAIL CODE FE
WASHINGTON DC 20546-0001**



Fold along line and tape closed.

Aeronautics—An Educator's Guide with Activities in Science, Mathematics, and Technology Education

EDUCATOR REPLY CARD

To achieve America's goals in Educational Excellence, it is NASA's mission to develop supplementary instructional materials and curricula in science, mathematics, geography, and technology. NASA seeks to involve the educational community in the development and improvement of these materials. Your evaluation and suggestions are vital to continually improving NASA educational materials.

Please take a moment to respond to the statements and questions below. You can submit your response through the Internet or by mail. Send your reply to the following Internet address:

http://ehb2.gsfc.nasa.gov/edcats/educator_guide

 You will then be asked to enter your data at the appropriate prompt.

Otherwise, please return the reply card by mail. Thank you.

- With what grades did you use the educator's guide?
 Number of Teachers/Faculty: _____
 _____ K-4 _____ 5-8 _____ 9-12 _____ Community College
 College/University - _____ Undergraduate _____ Graduate

 Number of Students:
 _____ K-4 _____ 5-8 _____ 9-12 _____ Community College
 College/University - _____ Undergraduate _____ Graduate

 Number of Others:
 _____ Administrators/Staff _____ Parents _____ Professional Groups
 _____ General Public _____ Civic Groups _____ Other
- What is your home 5- or 9-digit zip code? _____
- This is a valuable educator's guide?
 Strongly Agree Agree Neutral Disagree Strongly Disagree
- I expect to apply what I learned in this educator's guide.
 Strongly Agree Agree Neutral Disagree Strongly Disagree

Fold along line and tape closed.

- What kind of recommendation would you make to someone who asks about this educator's guide?
 Excellent Good Average Poor Very Poor
- How did you use this educator's guide?
 Background Information Critical Thinking Tasks
 Demonstrate NASA Materials Demonstration
 Group Discussions Hands-On Activities
 Integration Into Existing Curricula Interdisciplinary Activity
 Lecture Science and Mathematics
 Team Activities Standards Integration
 Other: Please specify: _____
- Where did you learn about this educator's guide?
 NASA Educator Resource Center
 NASA Central Operation of Resources for Educators (CORE)
 Institution/School System
 Fellow Educator
 Workshop/Conference
 Other: Please specify: _____
- What features of this educator's guide did you find particularly helpful?

- How can we make this educator's guide more effective for you?

- Additional comments:

Today's Date: _____ **EG-2002-06-105-HQ**